

Ultra-Low Temperature Freezer

Series YR05110

Instruction Manual

Thank you very much for purchasing our Ultra-Low Temperature Freezer model YR05110.

Please read the “Operating Instructions” and “Warranty” before operating this unit to assure proper operation. After reading these documents, be sure to store them securely together with the “Warranty” at a hand place for future reference.



Warning: Before operating the unit, be sure to read carefully and fully understand important warnings in the operating instructions.



OUR SERVICES

Benefits and Support

In Kalstein France, we take care of the full satisfaction of our customers, that is why we provide value-added services of the highest level based on our experience.



Online Inductions and Trainings

In any part of the world, receive your induction or training from our specialized team of engineers



Quick Response

Our work team is always available to response all your consults or questions, in order to support you in any situation.

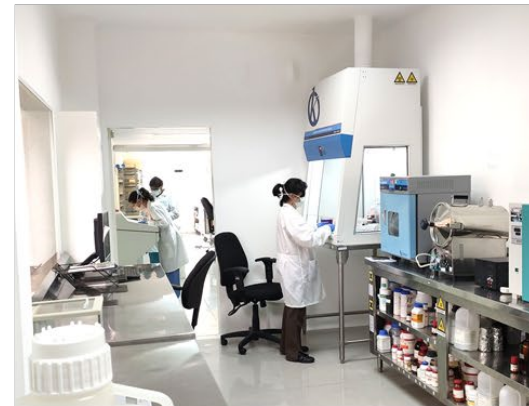

#Letsgivemore ♥

Thanks to your purchase, a donation will be made to a non-profit foundation that fights against breast cancer and helps most vulnerable communities.



Technical Support

Enjoy of personalized advice for the correct preventive and corrective maintenance of your equipment, thanks to Kalstein's manuals and articles, special catalogues and video tutorials.

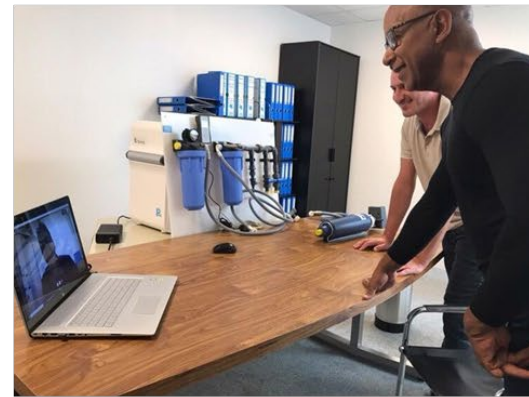

Delivery Logistics

We take care of all the necessary logistics for the dispatch of your goods, whether is by sea, land or air.



Kalstein Worldwide

With more than 25 years growing with our customers, Kalstein's multiformat and modern content, is now present in more than 10 countries and increasing.





CONTENTS

| | |
|---|----|
| I. Preface | 1 |
| II. Features | 1 |
| III. Precautions for Safe Operation..... | 1 |
| IV. Handling considerations..... | 4 |
| V. Precautions of using..... | 5 |
| VI. Ambient Conditions..... | 6 |
| VII. Installation..... | 6 |
| 7.1 Remove all packing materials..... | 6 |
| 7.2 Adjust the level feet..... | 6 |
| 7.3 Fixed appliance..... | 7 |
| VIII. Start-up of Appliance..... | 8 |
| IX. Components | 9 |
| X. System settings | 10 |
| XI. Control Panel Introduction | 13 |
| 11.1 USB data download | 14 |
| XII. Remote alarm contact..... | 19 |
| XIII. Compressor delay start time change..... | 19 |
| XIV. Alarm and safety features..... | 20 |
| XV. Routine Maintenance..... | 22 |
| 15.1 Clean the Cabinet..... | 22 |
| 15.2 Clean condenser filter | 22 |
| 15.3 Defrosting | 23 |
| XVI. Trouble Shooting..... | 23 |
| XVII. Freezer Rack (Optional)..... | 24 |
| XVIII. Specification | 24 |
| XIX. Performance | 26 |
| XX. Packing List..... | 26 |



I. Preface

- ❖ Please read the Operation Manual carefully before operation.
- ❖ We do not guarantee any safety if the appliance is used for any objects other than intended use or used by any procedures other than those mentioned in this manual.
- ❖ Please keep the Operation Manual at an approachable place.
- ❖ The contents of the manual will be subjected to change without notice due to the improvement of performance or functions.
- ❖ Please contact the sales representative or agency of us if you have any question of this operation manual.
- ❖ For any damage to the instrument the user is not required under this manual caused by, or individuals not in accordance with "Safety Tips" requires in the manual caused the damage, our company has no obligation and responsibility turbot responsible.
- ❖ Proper use of protective equipment (including clothing, gloves, goggles, etc.)
- ❖ The product is used only for storage.
- ❖ This product is non-explosion-proof products.
- ❖ Equipment maintenance can only be used by our company or authorized agents to complete.
- ❖ Prohibits the storage of live products, flowers, etc.

II. Features

- ❖ Microcomputer digital thermostat, operating temperature range -40°C~-86°C.
- ❖ Multiple protection features (Boot delay protection, compressor high temperature protection) .
- ❖ Internationally renowned brand compressors, stronger cooling capacity.
- ❖ Multi-layer adjustable independent storage space for easy access.
- ❖ Multiple door seals, interior and exterior insulation door design.

III. Precautions for Safe Operation

- ✓ It is imperative that the user complies with this manual as it contains important safety advice.
- ✓ Items and procedures are described so that you can use this appliance correctly and safely.
- ✓ If the precautions advised are followed, this will prevent possible injury to the user and any other person.



Warning

Failure to observe "WARNING" signs could result in a hazard to personnel possibly resulting in serious injury or death.



Caution

Failure to observe "CAUTION" signs could result in injury to personnel and damage to the appliance and associated property.



 **< Mark on the Appliance >**

This label is on the cover in which the electrical components of high voltage are enclosed to prevent the electric shock. The cover should be removed by a qualified engineer or a service personnel only.

 **< Mark on the Appliance >**

This label is on the outer surface of the device to remind the user to wear gloves to prevent frostbite when accessing the article.

 **< Mark on the Appliance >**

This label is marked around the hinge of the door to remind the user to pay attention to the hand when opening and closing the door.

 **< Mark on the Appliance >**

This label is marked around the rotating mechanism such as fan, gear, etc. to prevent accidental hand injury.

Only qualified engineering technicians or service personnel can remove the cover.

 **< Mark on the Appliance >**

This label is marked around the location where the combustible gas is stored to indicate that the device may leak combustible gas.

Only qualified engineering technicians or service personnel can service this equipment. Only qualified engineering technicians or service personnel can remove the cover.

 **Prohibition**

Failure to observe "Prohibition" signs otherwise it may cause damage to the save box or endanger the personal safety of the user.

 **< Mark on the Appliance >**

This label is marked around the door handle to indicate the door handle's opening and closing direction.



- ❗ **This appliance should only be installed by qualified engineers.** The installation by unqualified personnel may cause electric shock or fire.
- ❗ **The appliance should be installed on the solid floor with suitable measures to avoid overturning.** ❗ **Use a power outlet with a ground wire to prevent electric shock.**
- ❗ It is necessary to install a separate overload and leakage protector for the power supply.
- ❗ Before any repair or maintenance, be sure to disconnect the power supply.
- ❗ If the device is not operating properly, disconnect the power plug. If you continue to operate under abnormal conditions, it may cause electric shock or fire.
- ❗ Once the freezer is powered off, it will take more than five minutes to turn it on again to avoid damage to the compressor or system. The plug must be unplugged during maintenance.
- ❗ When restarting the device after a power failure or when the power is turned off, check the device settings.
- ❗ Gloves should be worn during repairs to prevent injury from sharp edges or corners.
- ❗ When removing the plug from the power outlet, hold the power plug firmly and do not pull the power cord. If you pull the cord by hand, it may cause electric shock or a short circuit that may cause a fire.
- ❗ After cleaning the dust from the power plug, insert the plug firmly into the socket.
- ❗ Before removing the device, unplug the power plug.
- ❗ When moving the equipment, be careful not to let the equipment fall over to prevent equipment damage or personal injury.
- ❗ When the equipment is not used for a long period of time, unplug the power plug.
- ❗ Users should follow the product manual and the product's own reminder label and warning label to operate, otherwise it may be dangerous or cause performance degradation.
- ❗ Hold the handle to open or close the door to avoid pinching your fingers.

DON'TS:

- ⊘ Do not install the device in a wet place or in a place that may splash in water. Otherwise, it may cause leakage or electric shock due to a reduced degree of insulation.
- ⊘ This device must not be placed outdoors.
- ⊘ Do not install this equipment in a place where flammable or volatile materials are stored. It may cause explosion or fire.
- ⊘ Do not install this device with an acidic or corrosive gas, otherwise it may cause leakage or electric shock due to corrosion.
- ⊘ Do not splash water directly on the device. Doing so may cause electric shock or short circuit.



- ⊘ Do not use loose power cords with plugs. This type of power cord may cause fire or electric shock.
- ⊘ Users must not disassemble, repair or modify the equipment themselves. If any of the above operations is performed by an unauthorized person, fire or personal injury may result from improper operation.
- ⊘ Wet hands should not be used to touch any electrical parts such as power plugs or any switches, as this may cause electric shock.
- ⊘ Do not insert metal objects such as nails or iron wires into any openings or gaps in the device or any outlets, otherwise electric shock or injury may occur due to accidental contact of the above objects.
- ⊘ Do not drill holes on the surfaces of this freezer, otherwise it will seriously affect the refrigeration performance.
- ⊘ Do not place containers or heavy objects with liquids on the device. If the item is dropped, it may cause injury to the person, and the flowing out of the liquid will cause the degree of insulation to decrease causing electrical leakage or electric shock.
- ⊘ Do not climb onto the device or place it on the device. Doing so can cause personal injury or damage to the device due to the device tipping over.
- ⊘ Do not put glass bottles into the cabinet as it may be damaged by freezing.
- ⊘ Do not touch stored objects directly with your hands. Direct contact with frozen objects or the inside of the equipment may cause frostbite. Wear antifreeze gloves.
- ⊘ The product is not used in conjunction with or in conjunction with other materials, components, technologies, and medical devices, nor is it in contact with other medical devices. The product does not have the function of treatment or adjuvant therapy.
- ⊘ Do not pull, strain, process, step on, squash, damage, or distort the power cord at any time to avoid leakage or even fire due to loose or damaged power cords.
- ⊘ The power cord must not be directly on the ground in order to avoid leakage accidents.
- ⊘ Do not store high humidity items in the product. This can cause serious frosting on the evaporator and affect the cooling performance.
- ⊘ Do not store high-temperature items in the product (the temperature of the items should be close to the temperature inside the box), otherwise it will cause serious temperature rise inside the freezer.
- ⊘ It is forbidden for personnel to enter this product, especially children, otherwise there may be casualties; if the equipment is left unattended for an extended period of time, it must be ensured that the child does not approach the equipment and the inside of the box cannot be completely closed.

IV. Handling considerations

- ❖ Use a forklift, and do not use a cart.
- ❖ When using forklift, insert it from the bottom of the freezer and move it.
- ❖ After removing the package, the freezer must be handled and it can be pushed by the caster.
- ❖ Note: The angle of inclination of the freezer must not be greater than 45° during handling.



V. Precautions of using

- ❖ When the freezer is running, the surrounding of the freezer frame may become hot. This is not a malfunction. In order to prevent condensation around the box frame, a dew-proof tube was installed around the cabinet.
- ❖ Before putting the items into the freezer, make sure that the temperature inside the box has dropped sufficiently, and then put the items in batches to prevent the temperature from increasing.
- ❖ Use a diluted, neutral detergent to clean the equipment (undiluted detergent will damage the plastic components. Refer to the detergent manual for the dilution method). Brushes, acids, gasoline, soap powder, polishing powder, or hot water should not be used to clean the freezer because the above materials may damage the painted surface and plastic rubber parts. Be careful not to wipe the plastic rubber parts with volatile solvents such as gasoline.
- ❖ When the battery is tested for the first time or when it is not used for a long period of time, there may be a situation where the battery is discharged because its rechargeable battery has been completely discharged. This does not mean that a failure has occurred. In this case, to maintain sufficient battery capacity, it is necessary to keep the freezer running for about 7 days.
- ❖ After the freezer is operated for a period of time, a layer of frost will form on the tank liner. If the frost layer is too thick, it will affect the cooling effect of the freezer and increase the power consumption. Therefore, when the frost layer reaches about 5mm at intervals, it should be defrosted.
- ❖ Before defrosting, please take the frozen items in the box and store it in another freezer to prevent the temperature inside the box from rising and damage the items.
- ❖ When the freezer is not used for a long time, the power should be turned off. Turn off the power switch and turn off the battery switch (if there is a corresponding switch).
- ❖ The speed should not be too fast every time the door is opened and closed, which may result in the difficulty of opening the door and the tightness of the door.
- ❖ The frequency of opening the door in use should not be frequent. It is better to open the door more than half an hour. Do not open the door more than 1 minute each time. Before closing the door, wipe the ice water on the door seal to ensure a good sealing effect. Failure to do so may cause the temperature in the freezer to remain below the set temperature, and at the same time reduce the frost on the evaporator and the inner wall of the tank.
- ❖ When an electrical fault such as a leakage or a short circuit occurs during use, immediately disconnect the power supply.
- ❖ After installing or moving the freezer for the first time, after it is in place, it needs to stand for 6 hours and then be powered on.
- ❖ When there are many items, please store them in batches. Each batch must not exceed one third of the volume of the cabinet. After placing the first batch of articles, wait for the temperature to stabilize before putting in the second batch to ensure that the temperature inside the box is stable.
- ❖ During the use of the freezer, if the door is opened for too long, the external hot air will enter the box, causing a high temperature alarm. This is a normal phenomenon. Please pay attention to reducing the time and frequency of door opening and closing as much as possible.
- ❖ In order to prolong the life of the freezer and reduce energy consumption, it is recommended that the temperature of the freezer is set between -40°C and -86°C .
- ❖ If the freezer does not cool after 2 to 3 hours of power-on, unplug it and contact service agency as soon as possible.
- ❖ Clean the condenser dust every three months to ensure the normal operation of the equipment.

- ❖ In the event of an alarm failure or other failure, please refer to the instruction manual to clear the fault according to the prompts on the display board. If you can not eliminate the fault by yourself, please do not disassemble it. Please contact the after-sale maintenance personnel to help eliminate the fault.

VI. Ambient Conditions

- ❖ Ambient temperature: 10°C-32°C. And the maximum temperature is no more than 32°C. The ideal temperature is 18 to 25°C. If necessary, an air conditioning system should be used.
- ❖ Ambient humidity: Maximum relative humidity 80%. For temperature up to 32°C, the humidity should be less than 60% RH.
- ❖ Avoid large amounts of dust.
- ❖ Avoid mechanical swing or vibration.
- ❖ The voltage fluctuation range shall not exceed $\pm 10\%$ of the rated voltage.
- ❖ Cannot be installed in a narrow and confined space.
- ❖ Please check the operating voltage before use, voltage instability should consider the use of regulator voltage regulator. To ensure that the normal input voltage is stable at 220V $\sim \pm 10\%$, the regulator power should be greater than 3kW.
- ❖ This equipment should ensure reliable grounding.

! Note:

- ❖ Because the cryogenic equipment is more sensitive to the ambient temperature. If it is installed in an environment other than the above, the machine will not operate normally. Please use it after improving the environment.
- ❖ It is forbidden to install this equipment in an open air environment. When the freezer is exposed to rain, it may cause leakage or electric shock.

VII. Installation

7.1 Remove all packing materials

Open the door to ventilate the appliance. If the outside panels are dirty, clean them with soft fabric plus diluted neutral detergent. (Undiluted detergent can damage the plastic components. For the dilution, refer to the instruction of the detergent). After the cleaning with the diluted detergent, always wipe it off with a wet cloth. Then wipe off the panels with a dry cloth.

7.2 Adjust the level feet

Turn the level feet clockwise to extrude the level feet, so as to contact the floor. Make sure to keep the appliance at horizontal status.

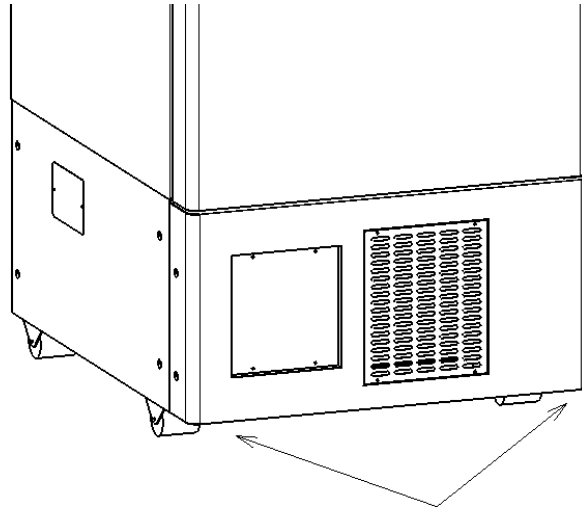

Level feet

7.3 Fixed appliance

Two fixed handles are installed at the back panel of the cabinet. Fix the cabinet on the wall with fixed handle.

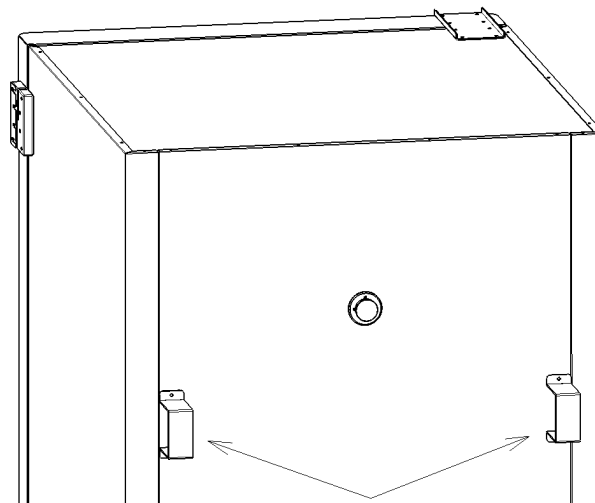

Fixed handle



Warning

- ❖ Use a power supply outlet with ground (earth) to prevent electric shock. If the power supply outlet is not grounded, it is necessary to install a ground by qualified engineers.
- ❖ Never ground the appliance through a gas pipe, water supply pipe, telephone line or lightning rod. Such grounding may cause electric shock in the case of an incomplete circuit.
- ❖ After the power is turned on, the power plug must be accessible to facilitate unplugging the power cord in an emergency. Any item must not cover the vent of the cryogenic freezer.

VIII. Start-up of Appliance

Follow the procedures for the test and formal operations of the appliance:

- ❖ Keep the device stand for at least 24 hours before turn on.
- ❖ Connect the power cord to the dedicated socket having appropriate rating and then turn on the power switch.
- ❖ Press the MUTE button to stop the alarm if the alarm sounds.
- ❖ Set the storage temperature as needed.
- ❖ Check the temperature in the cabinet if reached the setting temperature.
- ❖ Observation of the cabinet has normal opening and stopping for more than 24 hours, proof of normal performance of the cabinet.
- ❖ After confirmed the above, put a small amount of precooled articles (-40°C) into appliance to prevent temperature and the time interval at least 2 hours.
- ❖ When the Power off, then power on, the device will revert to the temperature set before the power off. The setting value of temperature and alarm temperature in the box is in Nonvolatile flash memory.
- ❖ Before placing the item in storage, confirm that the required temperature of the item is in accordance with the temperature range of the equipment, Prevent damage to items
- ❖ As a result of refrigeration inertia, the actual display of this product temperature and set the temperature has a certain difference (set the temperature of the lower the difference between the smaller the greater the contrary), this is normal
- ❖ All cabinet are storage equipment, is strictly prohibited to put too much of the relatively hot items, will cause the compressor for a long time non-stop, temperature does not drop and easy to cause compressor damage. Do not use appliances that have not been approved by the manufacturer within the enclosure.

IX. Components

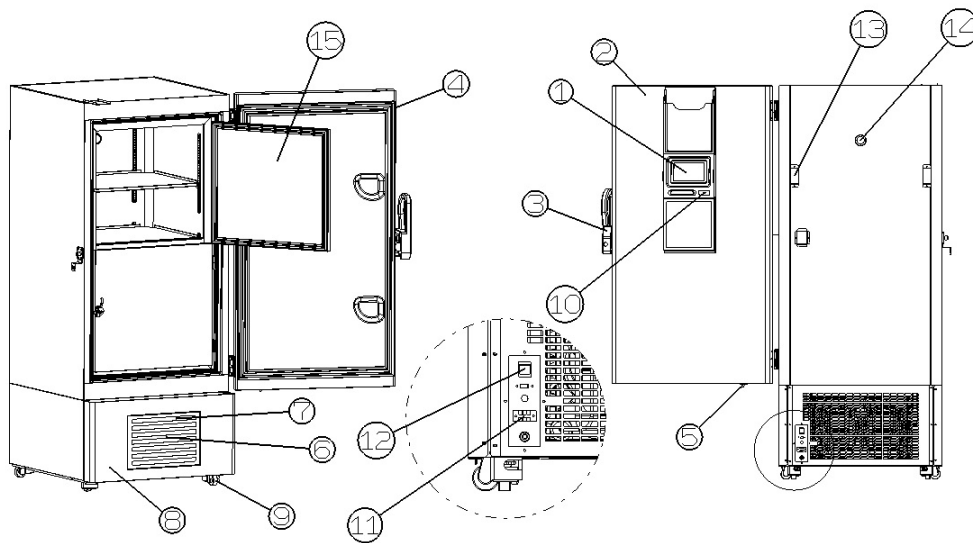

1. **Control panel** (on the wall of the external door): Display the temperature setting and indication of operating status.
2. **External door**: To open the door, grip the handle. When closing the door, please completely lock the external door handle.
3. **Handle**: Hold the handle to open and close the external door.
4. **Magnetic door gasket**: This provides a tight door seal and prevents cold air leak, please keep it clean.
5. **Door switch**: Detect the status of the external door (Open/Close).
6. **Air intake vent grille**: Do not block it to keep proper cooling performance.
7. **Condensing filter** (behind the grille): The filter can protect the condenser from dust. The dusty filter may cause damage for the refrigerating appliance. Clean the filter monthly.
8. **Space for temperature recorder**: An automatic temperature recorder can be attached here.
9. **Caster**: The height of the freezer can be adjusted by this screw type foot. Keep the appliance horizontal during installation. Make sure the rubber part of the casters contact the floor.
10. **USB port**: For data download of recent 10000 temperature records.
11. **Remote alarm terminal**: It is used for sending the alarm to the remote location.
12. **Power switch**: Turn ON/OFF the power supply. Power ON: "I", Power OFF: "O".
13. **Fixed handle** (at the back side): 2 fixed handles are used for keeping the gap between the appliance and the wall.
14. **Access port** (at the rear and bottom): This is used for leading a cable and sensor of a measuring appliance, or nozzle of back-up system to indoor.
15. **Inner door**: The operation of the inner door should be quick to minimize the temperature rise indoor. Lock the door latch completely when the door is closed. The door is removable for cleaning or defrosting. See page 12 "Routine maintenance".

X. System settings

- ✓ Enter the language selection interface when the device is powered on
- ✓ After selecting the language interface, the selected background color is green, click to enter the next step

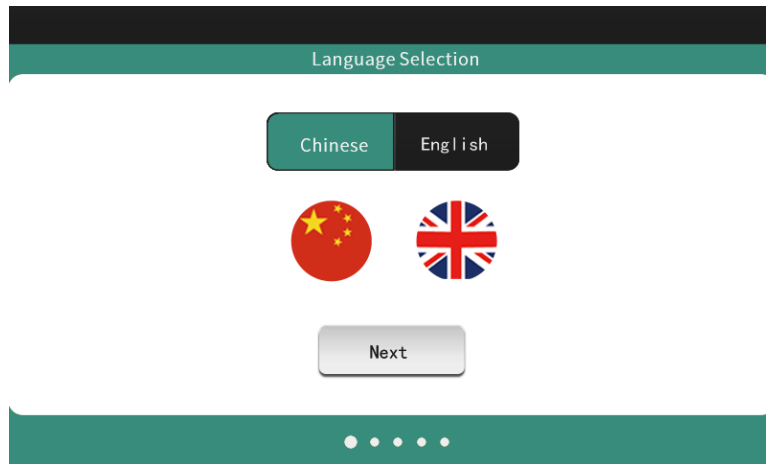

- ✓ After selecting the language, enter the initial setting of the system. The initial setting includes the current time setting and the system temperature unit setting.

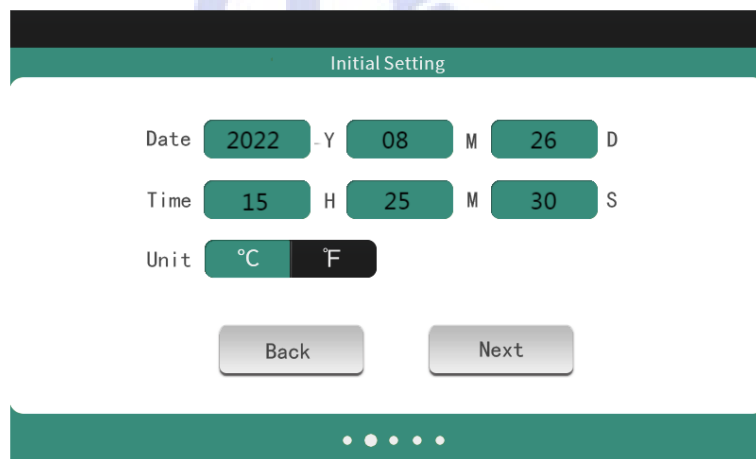

- ✓ Click the time displayed in the interface, and the time setting interface will be displayed

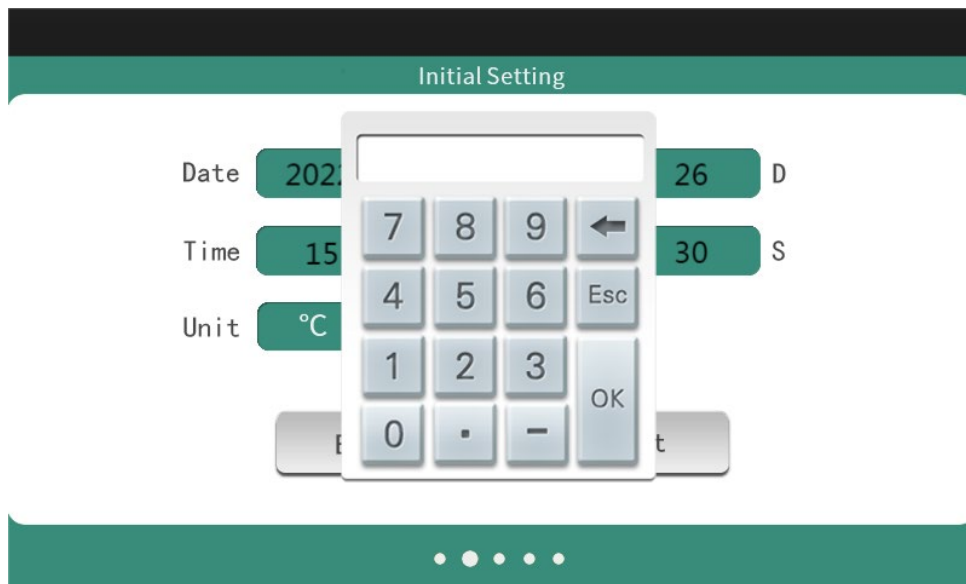

- ✓ Then enter the current time and click OK to complete the current time setting. The screen returns to the initial setup interface, if the current time is correct can directly carry out the system temperature unit setting, directly click on the interface of "°C" and "°F" for temperature unit selection, selected a background color is green, unchecked is a background color black(The following operations usually selected background is green, not selected background is black, no longer specifically described).Click "Next "when the initial time and temperature unit setup is complete.
- ✓ Enter system mode Setup when initial setup completes

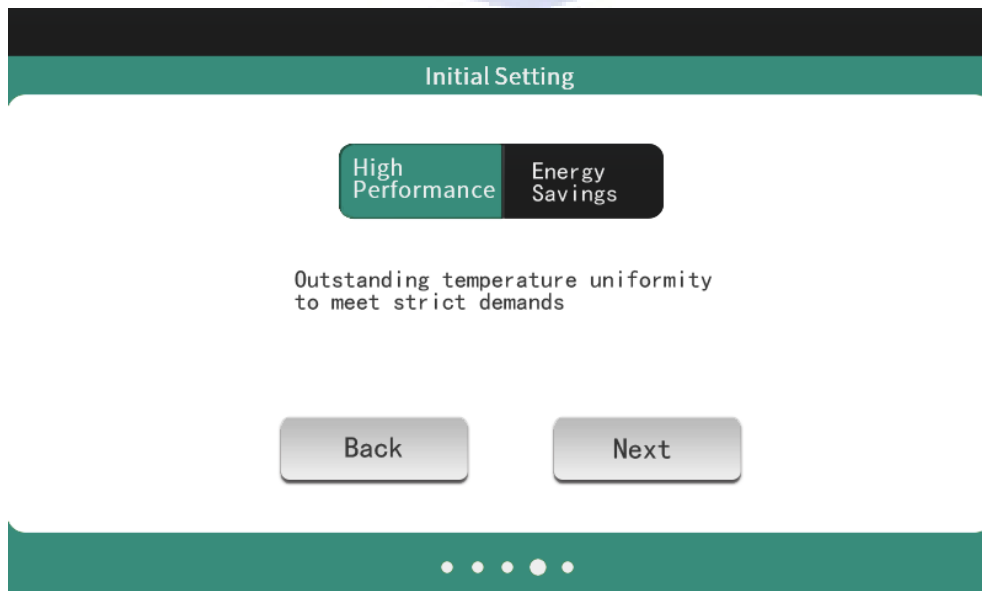

- ✓ There are two types of performance modes, high-performance mode and energy-saving mode, which can be selected. Working mode can be changed after entering the system. After setting the working mode, click "Next" to proceed to the next step.
- ✓ Access mode settings

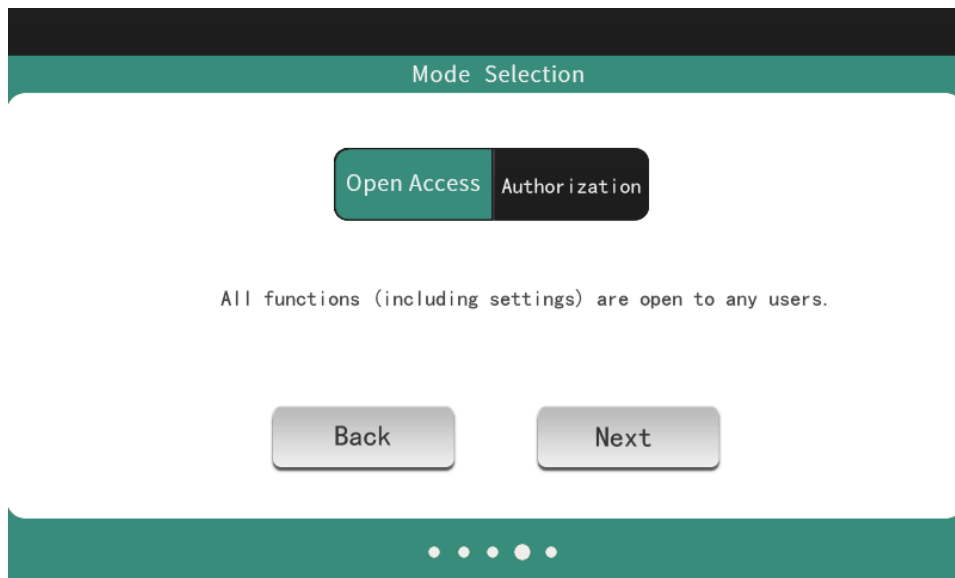

- ✓ In the authorization mode, there are two modes: Open Access and Authorization Mode. After selecting the authorization mode, it cannot be changed to open access without password.
- ✓ Select Open Access and click “Next” to enter the system; Select the Authorization mode and click “Next” to enter the authorization password.

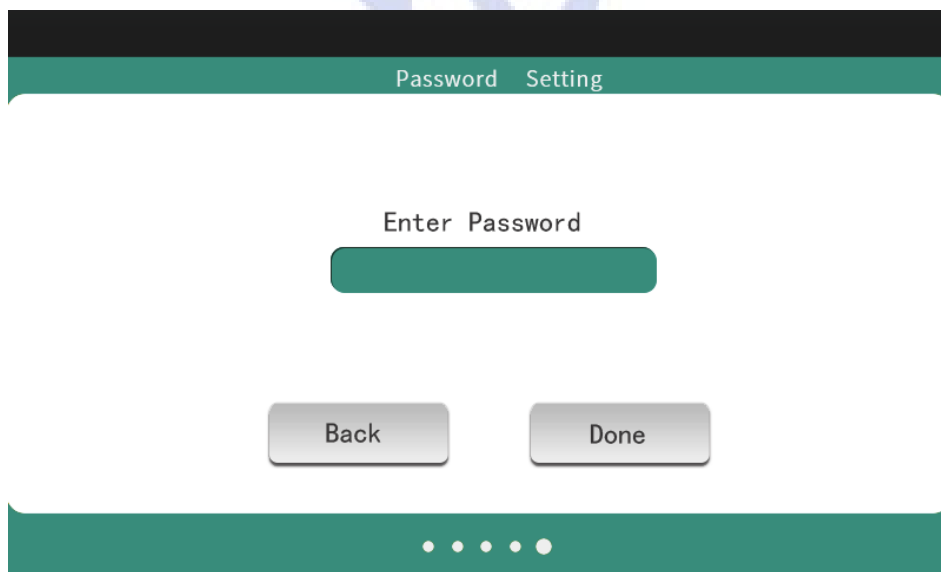

- ✓ Enter the correct authorization password in this interface to enter the system. (The initial authorization password is 123456. This password can be modified on the login interface after entering the system.)

⚠️ Note: After using the authorization mode to enter the system, some parameters need to use the authorization password to enter. In authorization mode, the device can only enter authorized mode to after power-off and restart.

XI. Control Panel Introduction

◆ Main page function introduction:

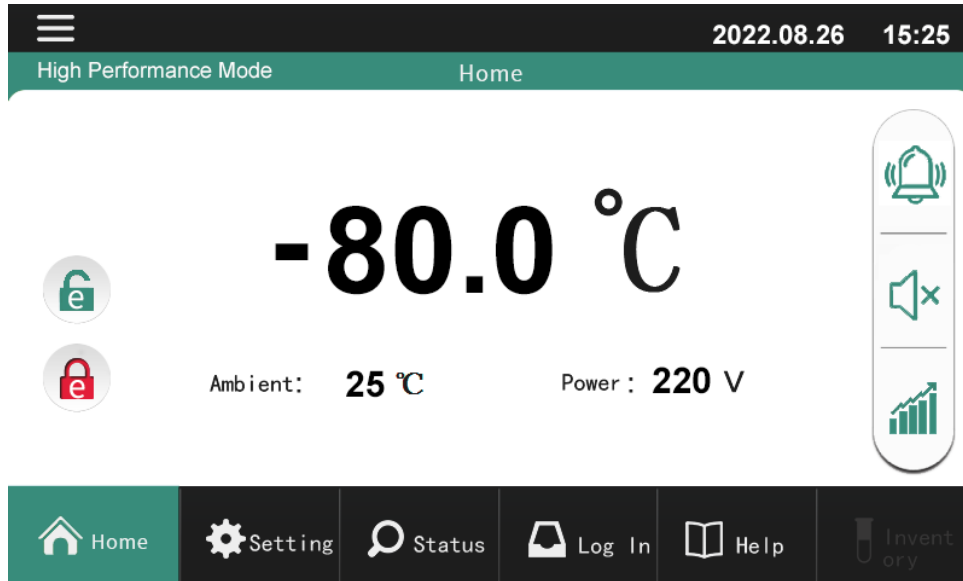

- ✓ **Home page middle area:** The center of the home page shows inner temperature, the lower left shows ambient temperature, the lower right shows current power voltage, the upper-left corner shows the system working mode (high-performance or energy-saving), the upper-right corner shows system time.
- ✓ **The left side of the homepage:**
 - ✓ **Unlock:** Unlock the screen before operate. If unlocked after 3 minutes without any operation, automatic lock screen. This icon is red when the screen is locked.
 - ✓ **Electronic Lock:** Optional function. The symbol appears when an electronic lock is started. Press the electronic lock, shows the keyboard, enter password and open the electronic lock. The key is green when the electronic lock is open.
- ✓ **The right side of the homepage:**
 - ✓ **Operating status:** When the device is operating normally, the color is green. Click to query all alarm information.
 - ✓ **Operation status:** When the device operation is abnormal, the color is yellow and flashes and beeps. The home display area will display the corresponding alarm icon and instructions
 - ✓ **Operating status:** When the equipment operation fails, the color is red and it flickers and an alarm sounds. The home display area will display the corresponding alarm icon and instructions
 - ✓ **Silence:** Press the“mute”button when alarming, and the buzzer stops.
 - ✓ **History curve:** Enter the history curve page.

11.1 USB data download



History curve: Enter the history curve page.

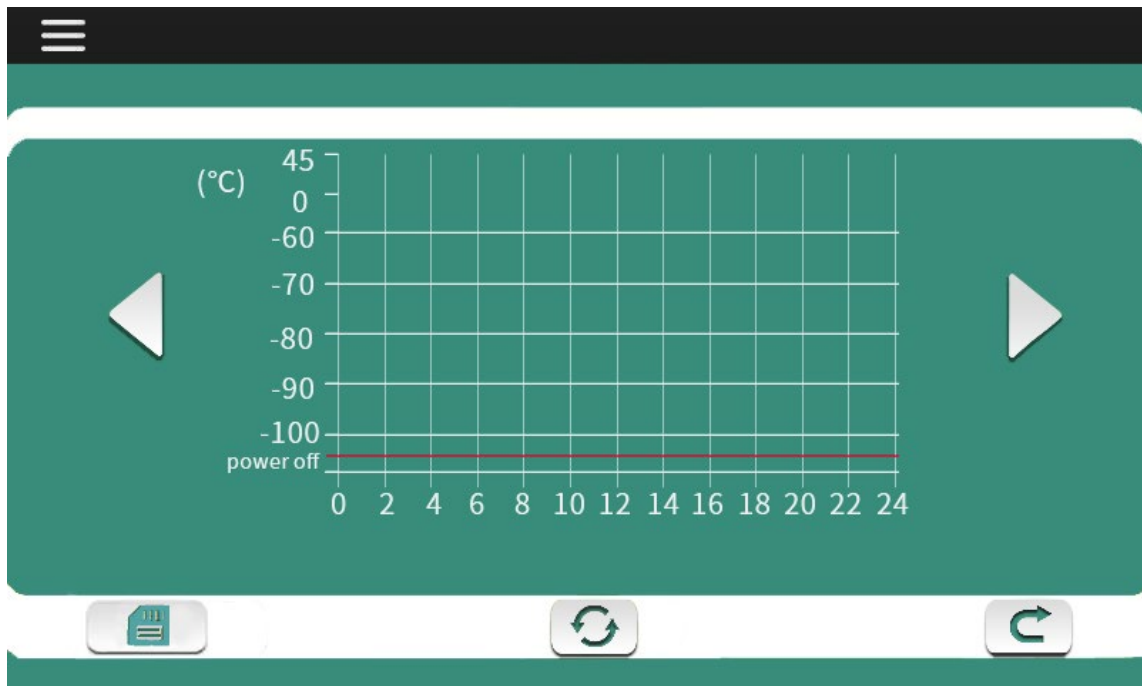

Click on the logo and wait for data download

When the interface appears: "Data saved, pull it out" It means data downloaded is finished

◆ Settings page function introduction:

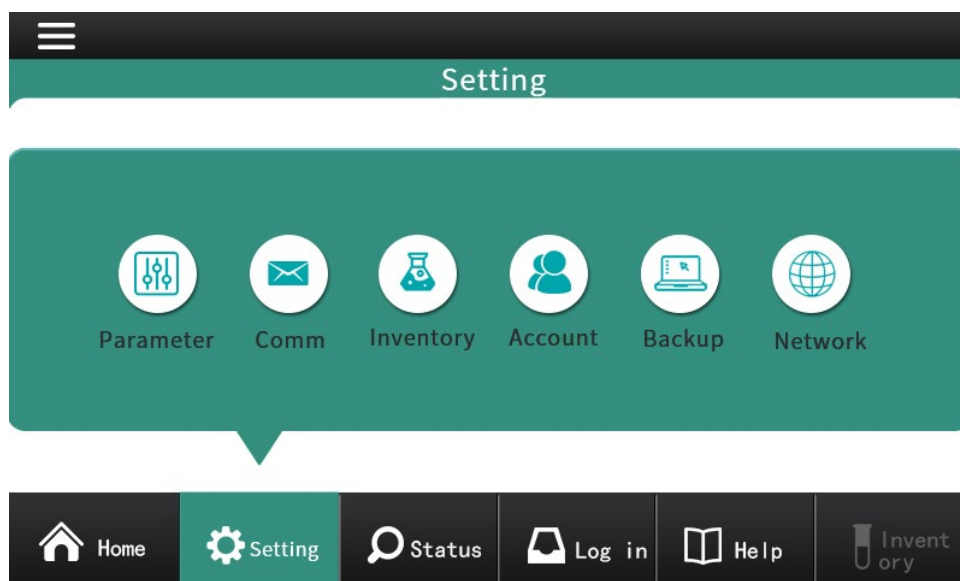

- ✓ **Parameter setting:** Set the temperature and alarm in the cabinet
- ✓ **Communication settings:** Set up the device SMS alarm function. (Optional function)
- ◆ **Introduction to parameter setting page:**
- ◆

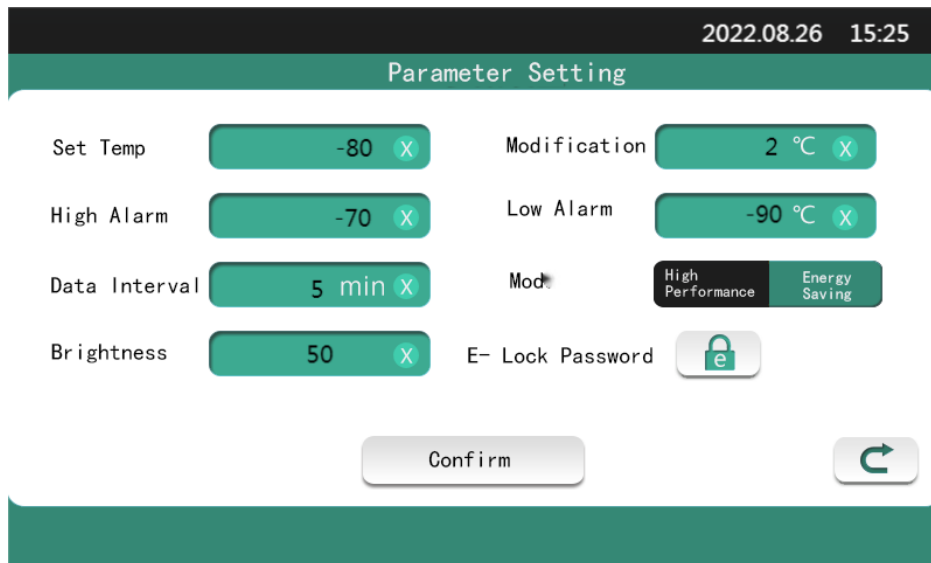



Note: When using licensing mode to enter the system, click on the parameter settings to enter the authorization password, the correct password can enter the parameter settings; When entering the system in open access mode, click enter parameter setting to enter the parameter setting page directly

- ✓ **Set temperature:** set the temperature in the cabinet.
- ✓ **Modification:** Calibration of sensor temperature measurement. Calibration should be done by authorized engineer.
- ✓ **High Alarm:** When inner temperature is higher than setting value, the high temperature alarm information appears.
- ✓ **Low Alarm:** When inner temperature is lower than setting value, the low temperature alarm information appears.
- ✓ **Data storage interval:** default data storage interval is 5 mins.
- ✓ **Mode selection:** Change the system's working mode (high-performance or energy-saving)
- ✓ **Screen Brightness:** Changes the brightness of touch screen.
- ✓ **E- Lock password:** Modify the password that opens the electronic lock. (Optional function).

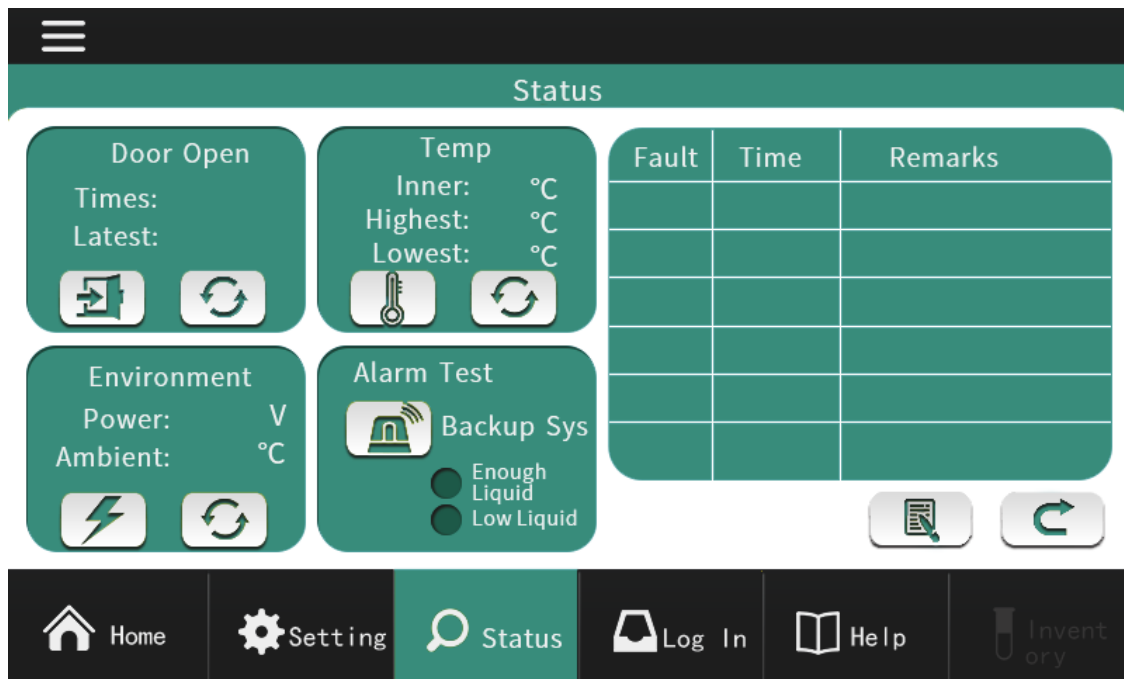

- Note:**
- ✓ The factory default temperature setting is -80°C.
 - ✓ The temperature controller has been set default parameters when leaving the factory. Please do not change other default parameters.
 - ◆ **Communication Settings (Optional function)**
 - ◆ **Status page function introduction:**



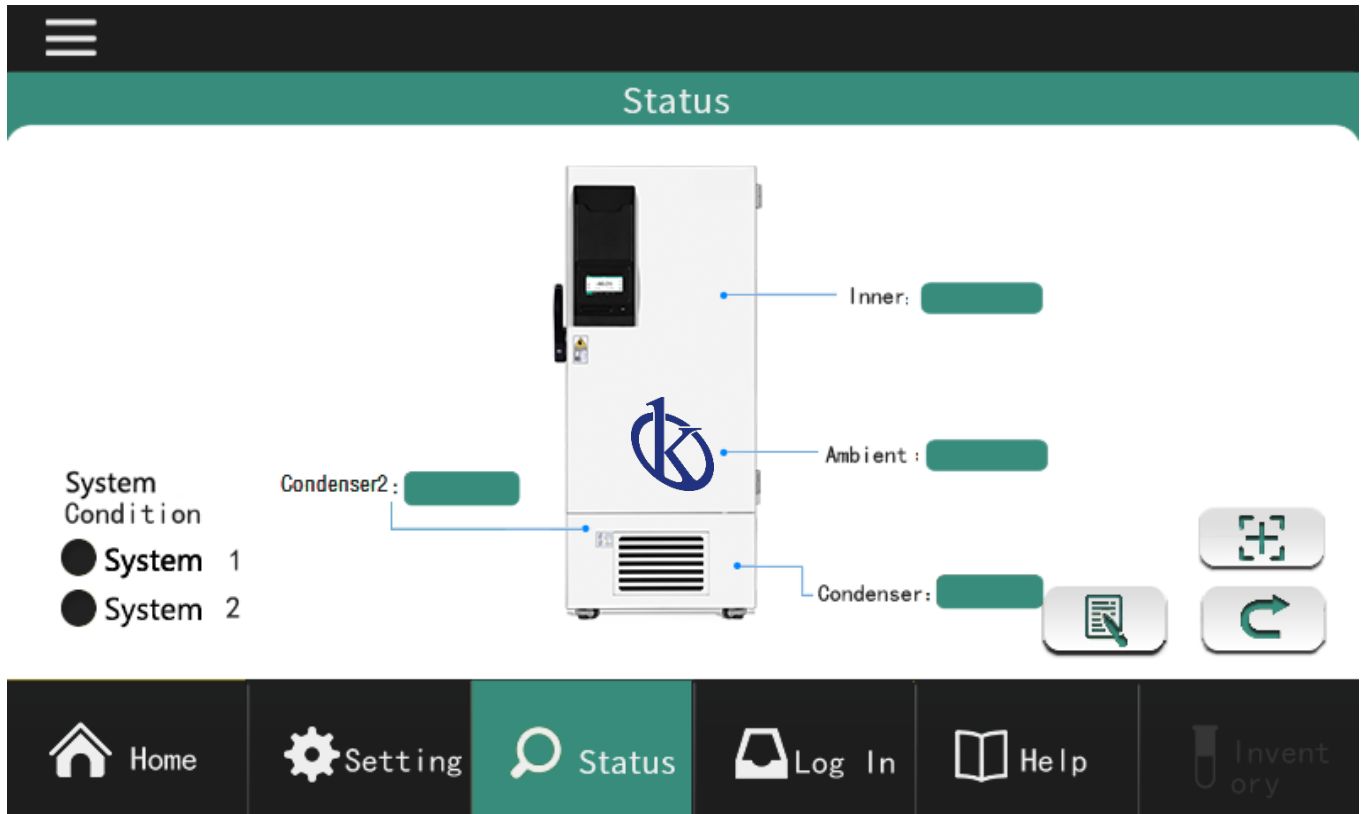

- ✓ The left area of the status module mainly displays the current information of the devices.
- **Door Open:**
 - ✓ Records the number of door opening alarm.
 - ✓  Open door alarm information refresh: Click the refresh button to count the number of times of opening door alarm
- **Temp:**
 - ✓ Shows current inner temperature, the highest and lowest temperature in last 24 hours.
 - ✓  Refresh temperature information
 - ✓  Click to enter freezer running status interface.

Introduction to the function of running state:



- ✓ **Compressor status:** The compressor icon is green when the compressor running; the compressor icon is gray when the compressor stops
- ✓ **Inner:** Displays the current temperature inside the cabinet.
- ✓ **Ambient:** Displays the current ambient temperature.
- ✓ **Condenser 1:** Displays the current condenser 1 temperature.
- ✓ **Condenser 2 / Heat Exchanger:** Displays the temperature of condenser 2 or heat exchanger.
- ✓  Enter the event information interface.
- ✓  Enter the screen calibration interface. (The screen is calibrated at the factory. If screen is normally, please do not press this button)
- ✓  Return.

- **Environment**
- ✓  Refresh the environment information.
- **Alarm test**
- ✓ Alarm test can enter the device alarm test interface, understand and test equipment alarm function.
- ✓  Alarm Test: Click to enter the device's alarm test interface.

Alarm test page function introduction:

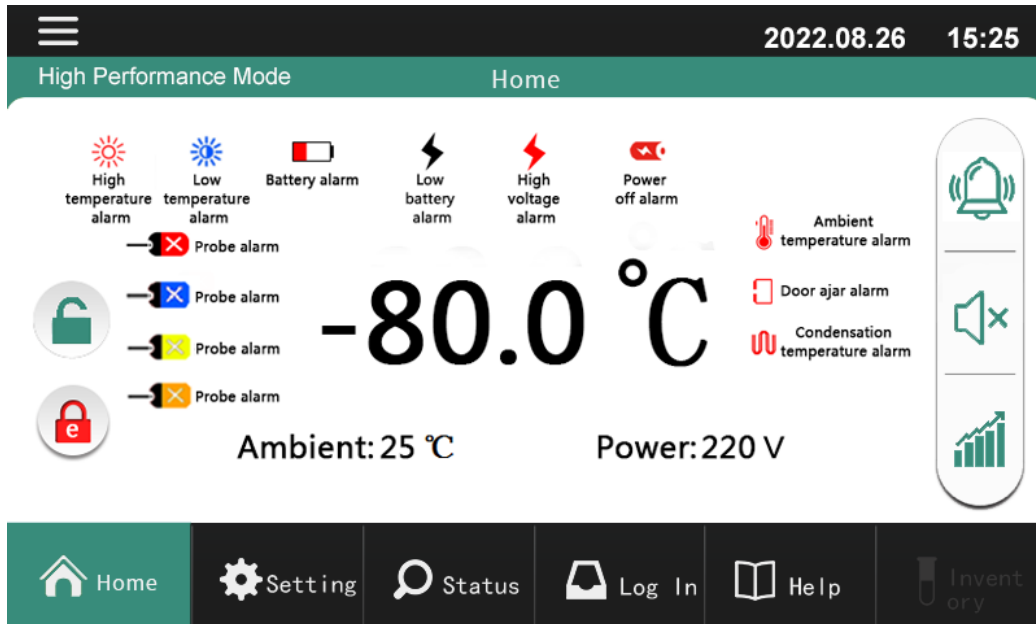

Click on the alarm test to start entering the alarm test:

- ✓ **Step 1:** the interface switches to the main interface for 10 seconds.
- ✓ **Step 2:** Verify the alarm status in order: high temperature alarm, low temperature alarm, door open alarm, and battery power anomaly alarm. At the same time, the alarm sound and running status icon turn yellow and blink.
- ✓ **Step3:** Verify status in order: When Probe failure, high ambient temperature, abnormal input voltage, the alarm sound and running status icon turn red and blink.
- ✓ **Step 4:** The main interface display alarm test completed, the page automatically switch back to the home page interface.

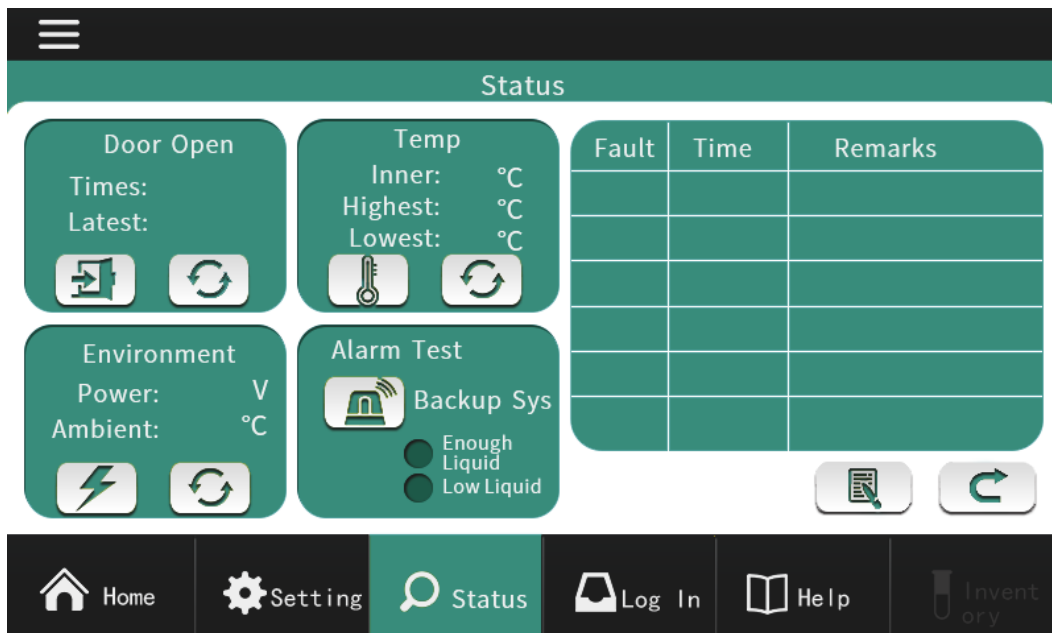

- The right area of the status bar mainly displays some device alarm information.
- ✓ In the fault list, the 6 most recent alarm messages will be displayed. The fault bar shows the alarm icon. The time bar shows the alarm occurrence time. The remark column shows the specific alarm content.



Enter the event information interface to view all the alarm messages that appear on the device.



Return to home page interface.

◆ Login interface introduction.

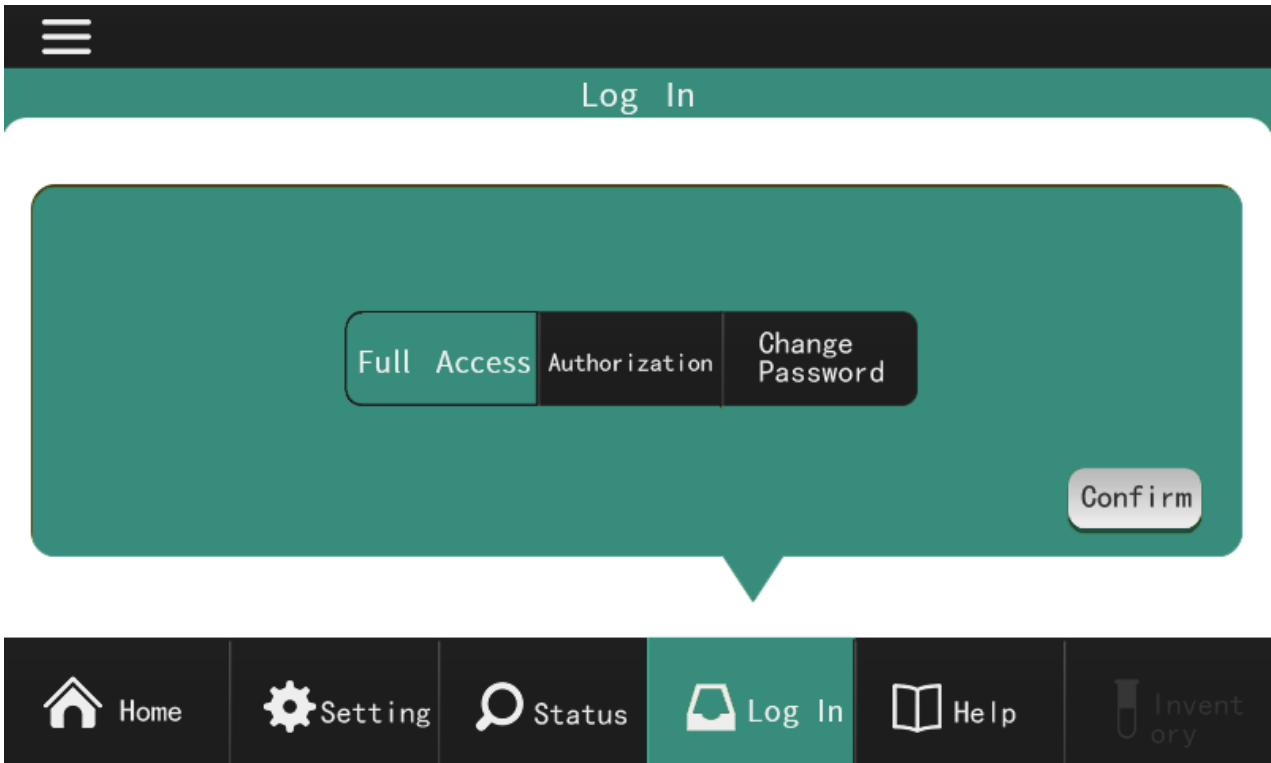

Note: Access to the system requires an authorization password to enter the login interface regardless of the mode of use.

- ✓ **Full access:** Click to enter normal mode.
- ✓ **Authorization mode:** Click to enter the authorization mode.
- ✓ **Change Password:** Click to modify the authorization password.

XII. Remote alarm contact

- ✓ The remote alarm contact is installed on the lower left side of the device. The alarm signal is output from this terminal.
- ✓ The terminal carrying capacity is DC 220V, 10A.
- ✓ Terminal output: the alarm terminals are in open circuit normally, and in closed circuit if there is alarm.

Caution: The alarm will be activated when the power cord falls down or the power supply cut off.

XIII. Compressor delay start time change







In order to drop the power load after power recovery, the delay of the compressor I could be modified.









 **Caution:**

- ✓ The delay during I and II compressor can't be modified.
- ✓ When the power capacity is enough, it is not necessary to modify the delay.

XIV. Alarm and safety features

| Alarm and safety features | status | Instruction | buzzer | Safe operation |
|--|--|---|--------|------------------------|
| Main sensor alarm | When the main probe in the cabinet is short-circuited or broken |  Probe alarm | Ring | Remote alarm activates |
| Ambient temperature probe | When the ring temperature probe in the cabinet is short-circuited or broken |  Probe alarm | | |
| Condensate Sensor alarm | When the condenser probe in the cabinet is short circuit or a broken circuit |  Probe alarm | Ring | |
| Heat exchange sensor alarm | When the Heat exchange probe in the cabinet is short circuit or a broken circuit |  Probe alarm | Ring | |
| Please clean the dust net | When the condensing filter is blocked or cooling fan is failure |  Condensation temperature Alarm | Ring | |
| Please check whether the outer door is closed | When the door opens more than a period of time |  Door ajar alarm | Ring | |
| High temperature alarm, please confirm whether to put a lot of items at one time or open the door too long | The temperature in the cabinet is too high |  High temperature alarm | Ring | |

| | | | | |
|--|---|--|------|------------------------|
| Low temperature alarm, please check the setting parameters are correct | The temperature in the cabinet is too low |  Low temperature alarm | Ring | Remote alarm activates |
| The power supply voltage is too high, please check the power supply voltage is normal | High voltage alarm |  | Ring | |
| The power supply voltage is too low, please check the power supply voltage is normal | Low voltage alarm |  | Ring | |
| Power supply is abnormal, please confirm the power failure or bad contact | Power abnormal alarm |  Power off alarm | Ring | |
| The battery is abnormal. Please keep it running for 24 hours. If the alarm is not cleared, replace the battery. | Low battery alarm |  | Ring | |
| The ambient temperature is too high, please check whether the product is well-ventilated around, such as in the summer, please confirm whether the air conditioning system is operating normally | Ambient temperature over 32 °C |  Ambient temperature alarm | Ring | |

The device has the alarm and safety functions shown in the table below and has a self-diagnostic function.



Note: When the power is switched off after power off, the device will resume operation with the temperature setting before power off.

The set points for the temperature in the cabinet and the alarm temperature are stored in the non-volatile flash memory.

XV. Routine Maintenance



Warning

- Warning: Always disconnect the power supply to the appliance prior to any repair or maintenance in order to prevent electric shock or injury.
- Make sure you will not inhale medicine or suspended particles around the appliance at the time of maintenance; these possibly be harmful to your health.

15.1 Clean the Cabinet

- Please clean the cabinet once a month. Periodical cleaning keeps the appliance looking new.
- Use a dry cloth to wipe off small amounts of dirt on the outside and inside of the appliance and all accessories, If the appliance is dirty, clean it with a diluted neutral dish washing detergent. (Undiluted detergent can damage the plastic components. For the dilution, refer to the instruction of the detergent.)After the cleaning with the diluted detergent, always wipe it off with a wet cloth. Then wipe off the cabinet or accessories with a dry cloth.
- Never pour water onto or into the appliance. Doing so can damage the electric insulation and cause failure.
- The compressor and other mechanical parts are completely sealed and the appliance requires absolutely no lubrication.
- The fan is installed behind the compressor, so please be very careful when insert the hand in this part.

15.2 Clean condenser filter

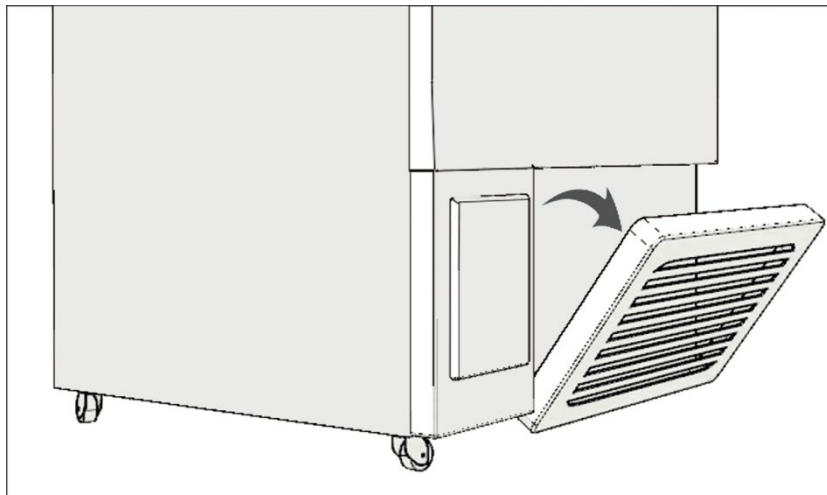

Filter replacement instructions, please following the steps to clean the filter:

- a. As shown in the picture, pull out the flip
- b. Get out of the filter net
- c. Clean the strainer with water and dry it
- d. Put the filter back in place and install the flip.
- e. Check if the alarm has been canceled if the condenser temperature alarm occurs before

 **Note:** Do not touch the condenser directly when cleaning the filter. The hot surface may be damaged.

15.3 Defrosting

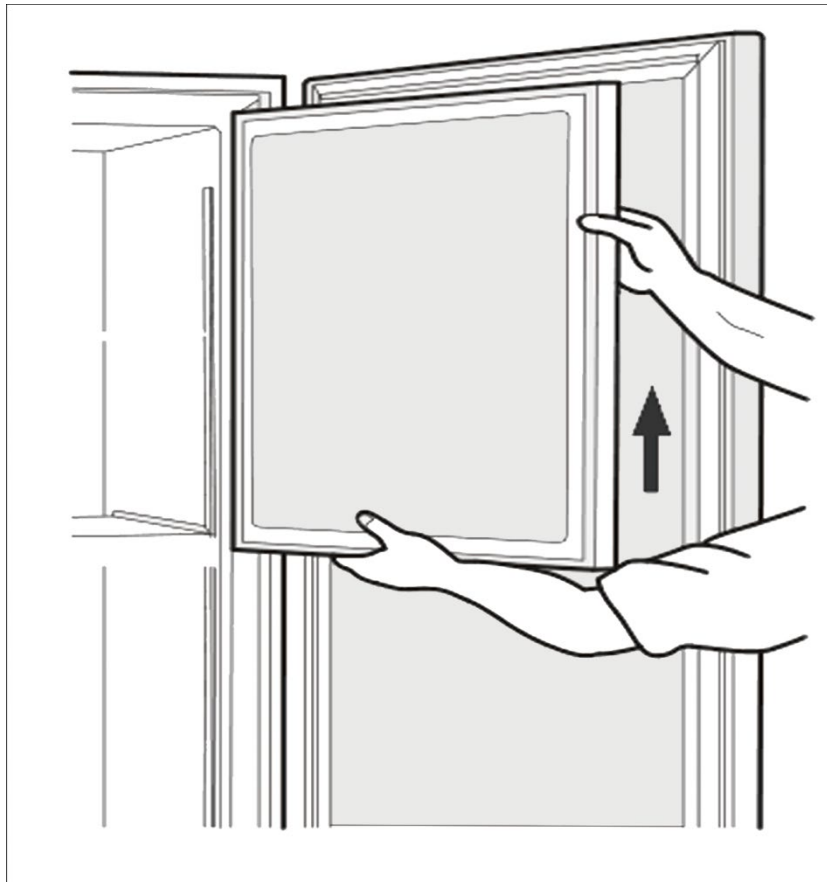

The frost is built at the upper portion of the appliance and inner door. The excessive frost possibly make some gap between the cabinet and door gasket, which may cause poor cooling. Remove the frost on the inner door with a scraper enclosed with the appliance. Defrost the cabinet with following steps.

 **Caution:** For removing the frost, do not use a tool with sharp edge such as a knife or a screwdriver

- Please turn off the backup cooling system if have.
- Take out and transfer all the objects to another cabinets or containers which is refrigerated by liquid carbon dioxide or dry ice.
- Turn off power switch of the freezer.
- Open the external door and internal door. Hold up the internal door and take it away.
- Keep the external door open to defrost for a moment.
- Clean the water with dry fabric from the bottom of the cabinet.
- After cleaning the cabinet and internal door, put the internal door back; please restart the appliance according to the "Switch on the Appliance".
- Put the objects into the thoroughly refrigerated cabinet.
- Turn on the back-up system if it is provided.

XVI. Trouble Shooting

Please check the fault as following before notifying the repair service:



| Faults | Checking/Solutions |
|---------------------------------|--|
| The cabinet is not fully cooled | <ul style="list-style-type: none"> ✓ Check the appliance if connect to the power supply? ✓ Check if the power voltage is too low? ✓ (Under this condition, please notify the electrician.) ✓ Check if the power switch is turned on? ✓ Check if the fuse blowing? ✓ Check if too much objects are stored in the cabinet? |
| Poor cooling performance | <ul style="list-style-type: none"> ✓ Check if the ambient temperature is too high? ✓ Check if the internal door is completely closed? Check if the external door is closed firmly? (The frost or ice between the cabinet and door gasket possibly prevents door seal) ✓ Check if the air inlet grille is blocked? ✓ Check if the filter is dirty and blocked? When the condenser alarm indicator lights on, please clean the filter and condenser. ✓ Check if the internal door is installed correctly? ✓ Check if the temperature is set correctly? ✓ Check if the grille is jammed? ✓ Check if the cabinet is far from direct sunlight? ✓ Check if the cabinet is near the heat source? ✓ Check if the rubber cover and insulating material of the cable port are installed correctly? ✓ Check if too much objects are stored in the cabinet? |

 Caution: If the problem is not solved or the problem is not listed in the above table, please contact with the after-sale technicians.

Disposal of Abandoned Appliance

 **Warning**

- If the appliance is to be stored unused in the open area for an extended period, ensure that children don't approach the appliance and the cabinet door can not be closed completely.
- The abandoned appliance shall be handled by appropriate personnel. Remove the cabinet doors to avoid accidents such as suffocation.

XVII. Freezer Rack (Optional)

- ✓ The optional freezer rack are useful to store the small size materials in the appliance effectively. When the racks are used, it is necessary to adjust the height of the shelves.

XVIII. Specification

| | |
|-------------|-------------------------------|
| Name | Ultra-low temperature freezer |
|-------------|-------------------------------|



| | |
|-------------------------------|--|
| Model | YR05110 |
| External Dimension(mm) | 1248×975 ×1994.5 (W*D*H) |
| Internal Dimension(mm) | 963×571×1350 (W*D*H) |
| Effective Volume | 728L |
| Exterior | Painted Steel Panel |
| Interior | Stainless steel |
| Outer Door | Painted Steel Panel |
| Inner Door | Stainless steel, 2 doors |
| Shelf | 3 stainless steel shelves (adjustable) Dimension: Width 937XDepth506(mm) Load: 40kg/shelf |
| cable Port | 25mm Diameter, 1 hole (back) |
| Insulation | Rigid polyurethane foamed and VIP |
| Compressor | Fully sealed |
| Evaporator | Tube type |
| Condenser | Copper-Aluminum finned |
| Refrigerant | Mixed refrigerant |
| Controller | Microcomputer control system |
| Temperature display | LCD display |
| Temperature Sensor | Platinum resistance (Pt 100) |
| Alarm | high-temperature alarm, low-temperature alarm, power failure alarm, door-open alarm, filter cleaning alarm, battery alarm, ambient temperature alarm, condenser alarm, fan alarm |
| Remote Alarm Terminal | Max capacity: DC220V, 10A |
| Battery | Lead-acid cell, DC12V, 7000mAh, automatic charging |
| Accessories | Defrosting scoop |
| Net Weight | 374kg |
| Optional Parts | Freezer Rack, Electric lock |



Caution:

- Design specifications are subject to change without prior notice.
- The battery for power failure alarm is consumable; it is suggested to replace it every 3 years for once. To replace the battery, please contact the representative of us, agent or after-sale service.



XIX. Performance

| | |
|---------------------------|--|
| Model | YR05110 |
| Cooling Performance | cabinet center-86°C(Ambient temperature 32°C, no-load) |
| Temperature Control Range | -40°C~-86°C(Ambient temperature 32°C, no-load) |
| Rated Voltage | AC220V,50Hz |
| Rated power | 1400W |
| Noise level | 55dB[A](background noise, 20dB) |

XX. Packing List

| Model | User Manual | Shelf | Buckle | Frost shovel | Position-limiting sheet metal | key |
|----------|-------------|-------|--------|--------------|-------------------------------|-----|
| Quantity | 1 | 3 | 12 | 1 | 2 | 2 |