

Camera Eyepiece Instruction Manual

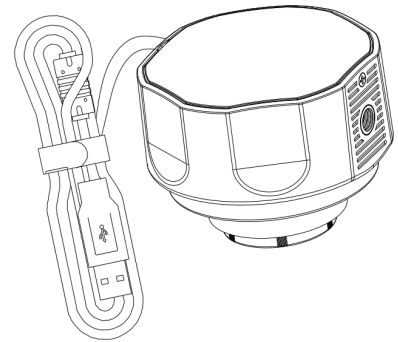

Thank you very much for purchasing our Camera Eyepiece for Trinocular Microscope.

Please read the “Operating Instructions” and “Warranty” before operating this unit to assure proper operation. After reading these documents, be sure to store them securely together with the “Warranty” at a hand place for future reference.



Warning: Before operating the unit, be sure to read carefully and fully understand important warnings in the operating instructions.



Contents

CHAPTER 1	NOTES AND SAFETY REQUIREMENTS	1 -
1.1	Cautions and Notes	1 -
CHAPTER 2	SOFTWARE SYSTEM REQUIREMENTS	2 -
2.1	System Requirements under USB Work Mode	2 -
CHAPTER 3	PACKAGE LIST	3 -
CHAPTER 4	FUNCTION INTRODUCTION	4 -
4.1	Name and function for body units of Camera Eyepiece	4 -
4.1.1	Body Introduction	4 -
4.1.2	Function for body units of Camera Eyepiece	5 -
4.2	Optional accessory Introduction	5 -
4.2.1	Connection methods and types	5 -
CHAPTER 5	PRODUCT ASSEMBLY GUIDE	6 -
5.1	Camera Eyepiece assembly and disassembly	6 -
5.1.1	Camera Eyepiece Assemble with Microscopes	6 -
5.1.2	Camera Eyepiece Disassembly	7 -
CHAPTER 6	INSTRUCTIONS	8 -
6.1	Install Micro Capture Software	8 -
6.2	To Connect Device	8 -
6.3	Open Software	8 -
6.4	Start to Use	8 -



Chapter 1 Notes and Safety Requirements

1.1 Cautions and Notes

- (1) To avoid danger or damage incurred to the lens, do not touch the lens or sensor directly with your fingers.
- (2) To avoid failure or electric shock hazard and so on, do not disassemble or modify the internal structure of the device.
- (3) Do not plug in or unplug the USB port when hands are wet.
- (4) Do not use alcohol and other organic solvents to clean.
- (5) If the lens or sensor is dirty or damp, you should better use dry and non-linen fabric or professional lens tissue to wipe them. To avoid scratches on the surface, do not touch the lens with your fingers. Wipe the lens or sensor lightly.
- (6) The products are not specifically designed for an outdoor use. Do not expose it to outdoor environment without any protection. Excessive temperature and humidity will damage the lens. Please avoid using the product under the following environment: high temperature or high humidity environment, places with direct sunlight, dirt or vibration and places near heat source.
- (7) Please use and store in the following environment:
Operating temperature : $-10^{\circ}\text{C} \sim 50^{\circ}\text{C}$
Storage temperature: $-20^{\circ}\text{C} \sim 60^{\circ}\text{C}$
Operating Humidity : 30~80%RH
Storage Humidity: 10~60%RH
- (8) If any foreign matter, water or liquid enter into the device by accident, disconnect the USB cable immediately. Please send it to the maintenance center and do not use the hair dryer to dry it by yourself.
- (9) To prevent microscope from being tripped over or dropped, please put away the device's USB cables in use or standby.
- (10) To avoid electric shock by accident, please power off microscope before you move your computer or laptop.
- (11) The cleanliness of the device lens will directly affect clarity degree of contents from the computer screen during preview. Problems like various circles or spots on the screen may mostly be incurred by dirt on the lens. When cleaning, please use professional lens tissue or other professional detergent to clear the dirt on the lens.

Chapter 2 Software System Requirements

2.1 System Requirements under USB Work Mode

- Windows XP SP3、Windows 7 (32 or 64 bits)、Windows 8 (32 or 64 bits)、Windows 8.1 (32 or 64 bits)、Windows 10 (32 or 64 bits) .
- Dual core 1.6 GHz or higher CPU
- USB 2.0 high-speed interface or USB2.0 compatible interface
- DVD-ROM driver (only needed when installing software)
- 2G or more memory
- At least 4 GB available hard-disk space





Chapter 3 Package list

1. Main body

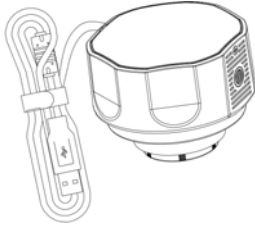

2. Installation disk



3. USB cable (Camera Eyepiece for B Port)

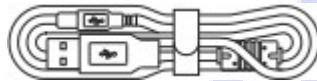

4. Eyepiece (optional accessory)

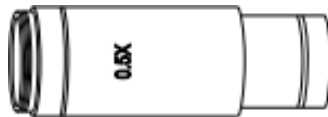

5. Adapter (optional accessory)



Chapter 4 Function Introduction

4.1 Name and function for body units of Camera Eyepiece

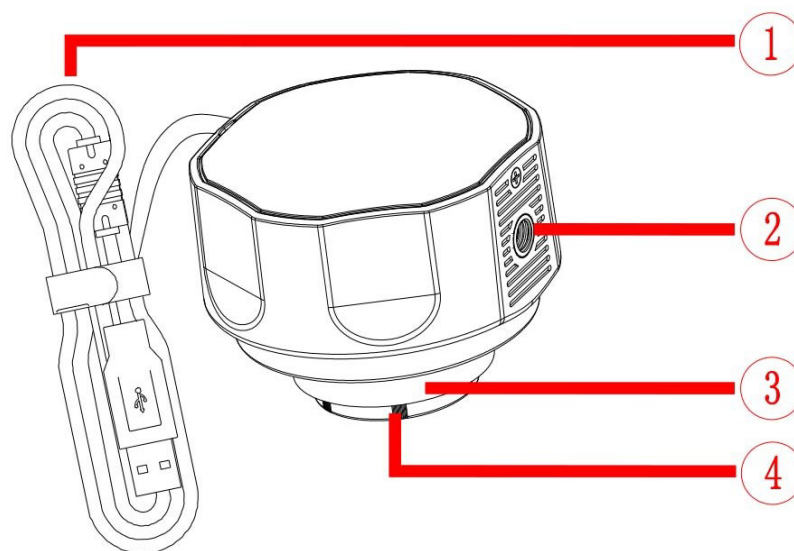

① USB cable

② Base Screw Holes

③ C-mount thread

④ Dust-proof cover

4.1.1 Body Introduction

Camera Eyepiece:

Standard C Port Camera Eyepiece suitable for adapter ring of 23.3mm, 30mm and 30.5mm, achieving connections with microscopes of different interfaces; the new 5 mega-pixel light-sensitive COMS chips significantly reduce the image noise, bearing characteristics of quick transmission speed, excellent color rendition, clear image and storage convenience, etc., which can be widely used in industrial tubes, teaching, material analysis, clinical examination, machine vision, etc.



4.1.2 Function for body units of Camera Eyepiece

1. **USB Cable:**Used for connecting camera to PC.
2. **Base Screw Holes:**1/4"-20screw hole (screw hole for camera) of coppernut,suitable for most tripods.
3. **C-mount thread:** make our camera can install to a standard C-mount microscope spotting scope; or can install to a different interface microscope with adapter (optional accessory). (For detailed specifications, please refer to Chapter 5)
4. **Dustproof Cover:** screw it out before use (tear filter protective film off for thefirst use) for dust prevention and chip protection.

4.2 Optional accessory Introduction

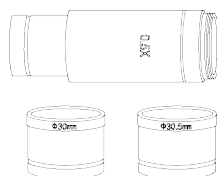

Adapter Ring and Eyepiece (Optional Components): Camera Eyepiece can be equipped into microscopes of different calibers through adapter ring and eyepiece. The Camera eyepiece body is of Standard C Port; 0.5X eyepiece is of 23.2mm; adapter ring is of 23.2/30mm, 23.2/30.5mm. According to different assembly methods, the equipment can be connected to eyepieces of different ports.

4.2.1 Connection methods and types

1. Install to a standard C-mount interface microscope.
2. Install to a 23.2mm interface microscope.

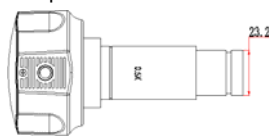

3. Install to a 30mm interface microscope.

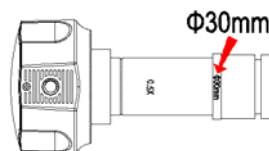

4. Install to a 30.5mm interface microscope.

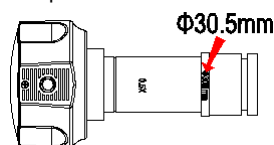

Chapter 5 Product Assembly Guide

5.1 Camera Eyepiece assembly and disassembly

5.1.1 Camera Eyepiece Assemble with Microscopes

1. Connection of Microscope for Standard C Port

- (1) Unscrew the plastic dustproof cover at the bottom of the Camera Eyepiece, take the protective film on the filter of the cavity (See Picture 1 and 2).
- (2) Screw the Camera Eyepiece to other microscopes (Standard C Port)(See Picture 3).
- (3) Connect the eyepiece to the computer and start the program.

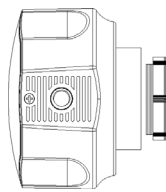

Picture 1

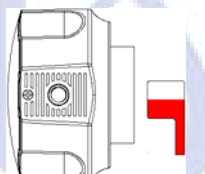

Picture 2

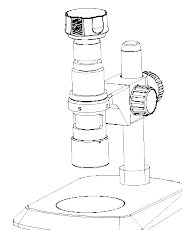

Picture 3

2. Connection with Stereomicroscope

- (1) Unscrew the dustproof cover of the Camera Eyepiece, take the protective film on the filter of the cavity.
- (2) Connect the eyepiece to additional eyepiece (See Picture 1 and 2).
- (3) Narrow the eyepiece cover (or empty sleeve) into 23.2/30mm adapter ring (or 23.2/30.5mm adapter ring).
- (4) Set the adapter ring with Camera Eyepiece to stereomicroscope (See Picture 3).

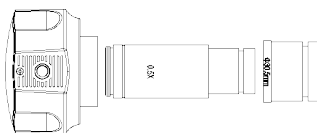

Picture 1

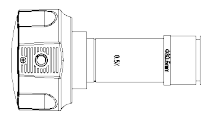

Picture 2

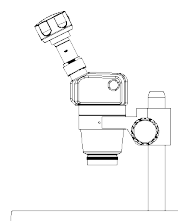



Picture 3



5.1.2 Camera Eyepiece Disassembly

1. Disassembly with Standard C Port Camera Eyepiece

- (1) Turn off the software and unplug the USD cable.
- (2) Screw out the Camera Eyepiece from the microscope.
- (3) Screw the plastic dustproof cover on.
- (4) Put the Camera Eyepiece in place in case of falling down.

2. Disassembly with Stereomicroscope

- (1) Take the product and adapter ring out from the stereomicroscope.
- (2) Disassemble the adapter ring and eyepiece from the product.
- (3) Screw the plastic dustproof cover on.
- (4) Put the Camera Eyepiece in place in case of falling down.

Chapter 6 Instructions

6.1 Install Micro Capture Software

Put the appendant disc into the DVD driver of your computer, click Micro Capture Install file and finish the installation of the application software according to the software reminder. For detailed install methods, please refer to *User Manual of Micro Capture English*.

6.2 To Connect Device

- (1) Connect the USB port of the Camera Eyepiece to the USB port of the computer.
- (2) It may appear the reminder for installing device's driver when you first use the Camera Eyepiece and then system will finish installation automatically.

6.3 Open Software

- (1) For the first time use, to install the Micro Capture software on the computer.
- (2) Run the Micro Capture software in the computer and observe the required image on the device.

6.4 Start to Use

- (1) Connect the Camera Eyepiece to the microscope according to requirements.
(For detailed specifications, please refer to Chapter 5)
- (2) Microscope aimed at the required viewing object , adjust the microscope object distance, to clearly see objects.
- (3) For detailed specifications, please refer to *User Manual of Micro Capture English*.