

Model YR01846

Visible Spectrophotometer

Instruction Manual

Thank you very much for purchasing our Model YR01846 Visible Spectrophotometer.

Please read the "Operating Instructions" and "Warranty" before operating this unit to assure proper operation. After reading these documents, be sure to store them securely together with the "Warranty" at a hand place for future reference.



Warning: Before operating the unit, be sure to read carefully and fully understand important warnings in the operating instructions.



OUR SERVICES

Benefits and Support

In Kalstein France, we take care of the full satisfaction of our customers, that is why we provide value-added services of the highest level based on our experience.



Online Inductions and Trainings

In any part of the world, receive your induction or training from our specialized team of engineers



Quick Response

Our work team is always available to response all your consults or questions, in order to support you in any situation.



#Letsgivemore

Thanks to your purchase, a donation will be made to a non-profit foundation that fights against breast cancer and helps most vulnerable communities.



Technical Support

Enjoy of personalized advice for the correct preventive and corrective maintenance of your equipment, thanks to Kalstein's manuals and articles, special catalogues and video tutorials.



Delivery Logistics

We take care of all the necessary logistics for the dispatch of your goods, whether is by sea, land or air.



Kalstein Worldwide

With more than 25 years growing with our customers, Kalstein's multiformat and modern content, is now present in more than 10 countries and increasing.



■ Safety

The safety statements in this manual comply with the requirements of the HEALTH AND SAFETY AT WORK ACT, 1974.

Read following instructions before installing and using the instrument and its accessories. The apparatus should be operated by appropriate laboratory technicians.

■ General

The apparatus described in this manual is designed to be used by properly trained personnel in a suitable equipped laboratory. For the correct and safe use of this apparatus it is essential that laboratory personnel follow generally accepted safe procedures in addition to the safety precautions called for in this manual.

The covers on this instrument may be removed for servicing. However, the inside of the power supply unit is a hazardous area and its cover should not be removed under any circumstances. There are no serviceable components inside this power supply unit. Please avoid touching the high voltage power supply at all times.

Some of the chemicals used in spectrophotometer are corrosive and/or inflammable and samples may be radioactive, toxic, or potentially infective. Care should be taken to follow the normal laboratory procedures for handling chemicals and samples.

■ Electrical

Before switching on the apparatus, make sure it is set to the voltage of the local power supply.

The power cord shall be inserted in a socket provided with a protective earth contact. The protective action must not be negated by the use of an extension cord without a protective conductor.

■ Warning

Any interruption of the protective conductor inside or outside the apparatus or disconnection of the protective earth terminal is likely to make the apparatus dangerous. Intentional interruption is prohibited.

Whenever it is likely that the protection has been impaired, the apparatus shall be made inoperative and be secured against any unintended operation.

NEVER touch or handle the power supply on due to the high voltage!

The protection is likely to be impaired if, for example, the apparatus

- Shows visible damage
- Fails to perform the intended measurements
- Has been subjected to prolonged storage under unfavorable conditions
- Has been subjected to severe transport stresses

■ Radio Interference

For compliance with the EMC standards referred to in the EC Declaration of Conformity, it is necessary that only shielded cables supplied by us are used when connecting the instrument to computers and accessories.

Contents

Chapter 1 Introduction	1
1.1 Measurement Principle	1
1.2 Performance and features	1
1.3 Application	2
1.4 Technical Specifications	2
1.5 Packing List	3
1.6 Symbols and Notices.....	3
1.7 Product Design.....	4
Chapter 2 Installation	7
2.1 Unpacking.....	7
2.2 Requirements	7
2.3 Installation	7
Chapter 3 Instrument Operation.....	8
3.1 Power On & Self-diagnosis.....	8
3.2 Basic Mode.....	9
3.2.1 Photometric measurement	10
3.2.2 Data processing.....	12
3.3 Quantitative Analysis.....	13
3.3.1 Standard curve measurement	13
3.3.2 Coefficient method application.....	18
3.3.3 Concentration unit setting	20
3.4 Kinetic Analysis	21
3.4.1 Kinetic analysis.....	21
3.4.2 Data processing.....	23
3.5 System Setup	23
3.5.1 Date &Time setting.....	24
3.5.2 Dark current calibration	24
3.5.3 Wavelength calibration	25
3.5.4 Restore factory defaults.....	25
3.5.5 Version information viewing.....	26
Chapter 4 Maintenance	27
4.1 Maintenance	27
4.2 Replacement of Tungsten Halogen Lamp	28
4.3 Fuse Replacement	29
Chapter 5 Troubleshooting	31

Chapter 1 Introduction

1.1 Measurement Principle

The measurement principle of spectrophotometer is based on the Lambert-Beer law. When the beam of collimated monochromatic light passes through a certain uniform colored solution, the absorbance of the solution is directly proportional to the concentration of the solution and the optical path. And it supplies basis for the quantitative analysis. The Lambert-Beer law is described as following formula:

$$A=k \times b \times C$$

A — Absorbance of the analyte

k — The absorption coefficient

b — The path length in cm

c — The analyte concentration

1.2 Performance and features

The performance and features of YR01846 Visible Spectrophotometer are as following:

- ✧ Low stray light and high resolution optical system enables accurate measurement with good stability and reproducibility.
- ✧ 24 bits high rate and high accuracy A/D conversion ensures the instrument with high sensitivity and fast response.
- ✧ 128×64 dots matrix LCD display enables clear and reliable display, and accurate readings.
- ✧ Wavelength, transmittance, absorbance, concentration and the standard curve, each is available for directly display.
- ✧ Standard curve establishing and measurement with the standard curve are available, continuous measurement and data storage is also available. User can save multiple standard curves, and load the standard curve according to the number as necessary. The test data can be saved automatically even if power off.
- ✧ With the standard USB port, powerful function of system settings, measurement functions such as photometric analysis, quantitative analysis, wavelength scan, kinetic analysis and multiple wavelength analysis, and data processing are available if chosen with certain application software.

1.3 Application

The visible spectrophotometer is a common analytical instrument in chemistry laboratory, and it is widely used in pharmaceutical, medicine & health, chemical, energy, machinery, metallurgy, environmental protection, geology, food, biology, materials, agriculture, forestry, fisheries and other industries. It's also applied in the fields of higher education, metrology, teaching and scientific research, and has advantages in quality control, raw material and product inspection in production. With its stable performance, accurate measurement and powerful functions, YR01846 Visible Spectrophotometer has obvious advantages in many fields of scientific research and quality control.

1.4 Technical Specifications

Model	YR01846
Wavelength Range	320 nm -1100 nm
Bandwidth	2 nm
Wavelength Accuracy	±0.8 nm
Wavelength Repeatability	≤0.3 nm
Photometric Range	0 - 200 %T, -0.3 A - 3 A, 0 - 9999 C
Photometric Accuracy	±0.3 %T
Stability	≤0.002 A/30min @ 500 nm
Stray Light	≤0.05 %T@ 360 nm
Data Output Port	USB
Printer Port	RS 232
Display	128×64 dots LCD
Light Source	Tungsten Halogen Lamp
Detector	Silicon Photodiode
Power Requirement	220 V /50 Hz or 110 V /60 Hz
Dimensions	480 mm × 380 mm × 210 mm
Net Weight	18 kg

1.5 Packing List

No.	Item	Unit	Qty	Note
1	YR01846 Visible Spectrophotometer	set	1	
2	Power Cord	pc	1	
3	Glass Cell	kit	1	4 pcs/kit
4	Dust Cover	pc	1	
5	User's Manual	pc	1	
6	Quality Certificate	pc	1	
7	Packing List	pc	1	

1.6 Symbols and Notices



: HIGH VOLTAGE

Caution the danger of high voltage, and be careful of the risk of electric shock.



: HOT SURFACE

Caution the hot surface, and avoid the risk of burn.



: WARNING

Be sure to set the instrument's voltage switch at your local power supply, or severe damage may occur!



: NOTICE.

Pay attentions to the notice.



: SPECIAL EXPLANATION.

Pay additional attention to the special explanation.

1.7 Product Design

1. Configuration

The profile of YR01846 Visible Spectrophotometer is shown in Fig. 1-1:

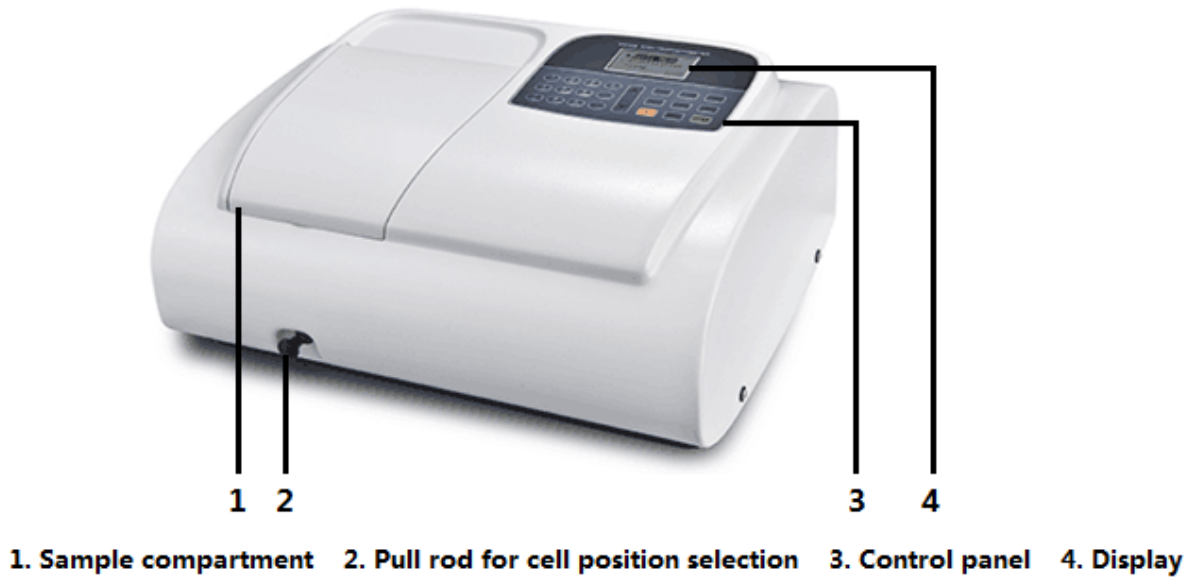

Fig. 1-1

The back side of YR01846 Visible Spectrophotometer is shown in Fig. 1-2:

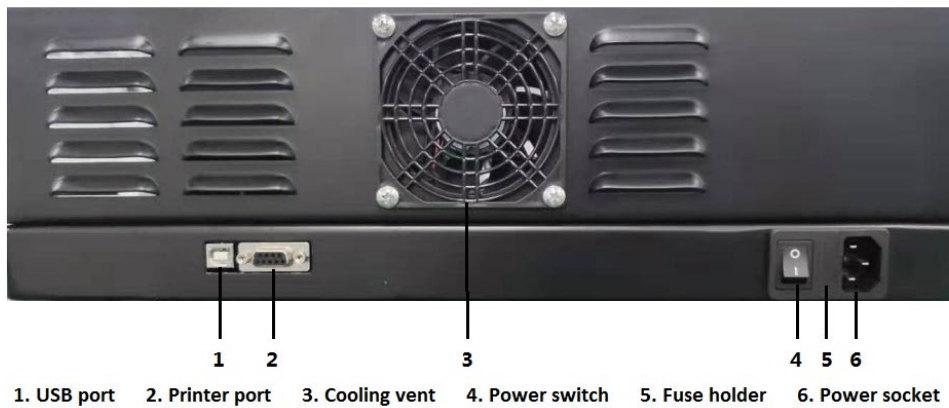

Fig. 1-2

The schematic diagram of the instrument's internal structure is shown in Fig. 1-3:

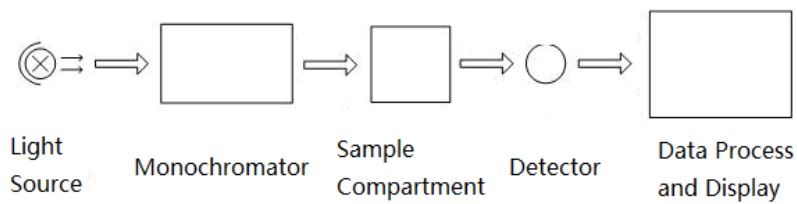

Fig. 1-3

2. Control Panel and Keys

The control panel of YR01846 Visible Spectrophotometer is shown in Fig. 1-4.:



Fig. 1-4

The keys include number keys and function keys. Following are the description of the keys.

1) Number keys



Input the value such as wavelength, concentration, and date.

2) Function keys

GOTOλ: For wavelength setting.

ZERO: For blanking, adjust to 0.000 Abs or 100.0 %T.

START STOP: Start or stop the measurement.

ENTER: Enter key, to confirm the setting or the operation.

SET: For parameters setting or measurement mode selection.

CELL: For cell position control. It's only available for the instrument with the accessory of automatic cells holder

PRINT: For data print out.

CLEAR: Clear or Delete key, to delete the wrong input during the parameters setting, or clear the testing data.

: Up key, to move up.

: Down key, to move down.

ESC: Esc key, to exit the current interface, and return to the previous interface.



Chapter 2 Installation

Please carefully read the instruction in this chapter before unpacking and installation YR01846 Visible Spectrophotometer.

2.1 Unpacking

Please check the outer packing and make sure that it is intact before unpacking YR01846 Visible Spectrophotometer. Then, check the instrument and its accessories according to the packing list and make sure they are completely well. If you have any questions, or anything lost or damaged, please contact us in time.

2.2 Requirements

A laboratory should be prepared, and following requirements should be met:

- 1) The instrument should be placed in a dry room, and the room temperature should be in the range of 10 °C~35 °C. The relative humidity should be no more than 85%.
- 2) Power supply requirement: The rated voltage should be 220 V ± 22 V AC (110 V ± 11 V AC is also optional), and the frequency should be 50 Hz (60 Hz is also optional). Well grounding is also required. An electronic AC regulator or AC regulator with the power more than 1000 W is suggested to enhance the anti-interference performance of the instrument.
- 3) Other requirements: Be far away from strong or continuous vibration. Neither setting up the instrument near electromagnetic field, nor exposing the instrument to direct sunlight or the radiation of heaters. It should be free of dust, as well as corrosive vapors. The instrument should be placed on a stable workbench. And for well cooling and ventilation, a clearance of at least 15 mm to the wall is suggested.

2.3 Installation

Install the instrument as following steps:

Step 1: Place the instrument onto a stable bench after unpacking.

Step 2: Connect the power cord to the instrument. If a printer is equipped, connect the power cord of the printer and connect the instrument to the printer with the communication cable.

Chapter 3 Instrument Operation

Before switching on the power, make sure that all connections work well, the power supply is with well grounding and met the requirement, neither sample in the sample compartment nor any other block in the light path.

 : Be sure to set the instrument's voltage switch at your local power supply, or severe damage may occur! The voltage switch is on the bottom of the instrument, and the default voltage switch is on the position of 220 V.

If your local Voltage is 220V, you should set the voltage switch at the following status (Fig.3-1). If your local Voltage is 110V, you should switch it to another side by your hand (Fig.3-2).



Fig. 3-1



Fig. 3-2

YR01846 Visible Spectrophotometer is available for automatic control function such as power on and self-diagnosis, system setup, measurement function such as Basic Mode, Quantitative and Kinetics, and data processing function such as data save, print and delete.

3.1 Power On & Self-diagnosis

1. Power On & Self-diagnosis

Switch on the power after connecting the instrument to the power supply, and a welcome interface will be shown, then, it will quickly enter the self-diagnosis interface (Fig. 3-3). The system will run the self-diagnosis items such as filter, detector, wavelength calibration, system parameters, dark current, and so on.



Fig. 3-3

 If any item is fail in the self-diagnosis process, the system will automatically give buzzing alarm, and the item will be marked with “x”. However, user can press any key to skip the item and continue the self-diagnosis for next item.

 Please don't open the lid of the sample compartment during the self-diagnosis process. Please contact us in time if any self-diagnosis item fails. Otherwise, refer to chapter 5 for troubleshooting.

2. Pre-warming

It will enter the pre-warming interface (Fig. 3-4) after completing self-diagnosis. The pre-warming will cost 20 min. The system will automatically give buzzing alarm when the pre-warming is completed, and it will enter the main interface. User also can press any key to skip the pre-warming process and enter the main interface directly.

3. Ready for operation

It will enter the main interface (Fig. 3-5) after pre-warming, and it's ready for operation.

Functions such as Basic Mode, Quantitative, Kinetics and System setup are available with the instrument operation.

User can press “▲” or “▼” to select the right function and press “ENTER” to enter the operation interface.

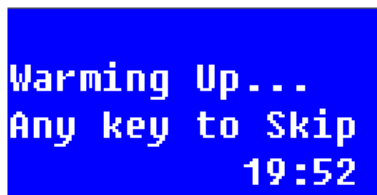

Fig. 3-4

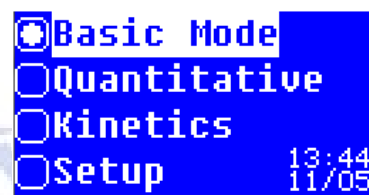

Fig. 3-5

3.2 Basic Mode

Photometric measurement such as absorbance, transmittance, and energy measurement under certain wavelength is available with Basic Mode. The measurement result also can be print out.

Press “▲” or “▼” to select the function in the main interface and press “ENTER” to enter Basic Mode interface (Fig. 3-6).

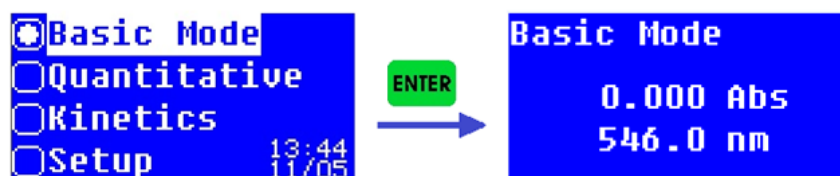

Fig. 3-6

3.2.1 Photometric measurement

Following are the operation steps for photometric measurement:

Step 1: Enter Basic Mode interface (Fig. 3-6).

Step 2: Select the measurement mode.

Press “**SET**” to select the measurement mode after entering Basic Mode interface (Fig. 3-7). Press “**▲**” or “**▼**” to select the measurement mode and press “**ENTER**” to make sure the selection. Then, press “**ESC**” to return to Basic Mode interface, and the chosen measurement mode is shown.

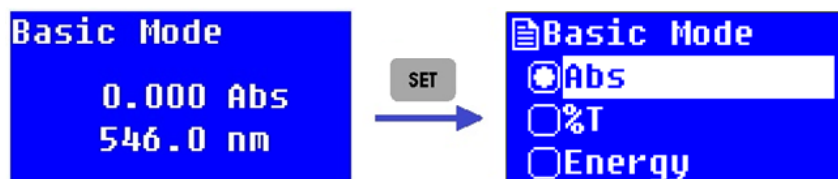

Fig. 3-7



 User can check the energy when choosing the energy mode (Fig. 3-8). Press “**▲**” or “**▼**” to select the energy gain, a certain energy value will be shown at the same time.



Fig. 3-8

 Energy mode is usually for instrument adjusting. For convenience of normal measurement, please press “**ESC**” in time to return to the measurement mode selection interface after checking the energy. Then select Abs mode or %T mode and press “**ENTER**”, and later press “**ESC**” to return to Basic Mode interface.

Step 3: Set the measurement wavelength.

When entering the Basic Mode interface or measuring interface, press “**GOTOλ**” to enter the wavelength setting interface (Fig. 3-9). Input the wavelength value according to the prompts and press “**ENTER**”, the instrument will move wavelength to the designated spot.

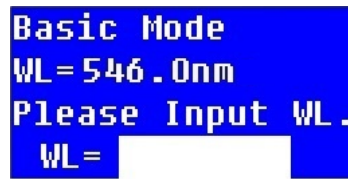



Fig. 3-9

-  The valid wavelength range of YR01846 Visible Spectrophotometer is between 320 nm and 1100 nm. If the input value is out of the range, the system will automatically give buzzing alarm and return to the previous interface.
-  User can press “CLEAR” to clear the input when an error is found, then input the target value again. The key “CLEAR” also works in the process of digital setting in subsequent operations.

Step 4: Sample measurement.

For simple measurement (direct reading): In Basic Mode interface, put the blank solution or reference solution into the light path, and press “ZERO”. The instrument will be adjusted to 0.000 Abs/100.0 %T under certain wavelength. Then, replace the blank solution or reference solution with the sample solution, and user can directly read out the measurement result.

For several samples or multiple measurements: In Basic Mode interface, press “ENTER” to enter the measuring interface. If it is already in the measuring interface, just continue the following operation. Put the blank solution or reference solution into the light path, and press “ZERO”. The instrument will be adjusted to 0.000 Abs/100.0 %T under certain wavelength. Then, replace the blank solution or reference solution with the sample solution, press “START STOP” to record the measurement result (Fig. 3-10). Multiple measurements can be recorded.

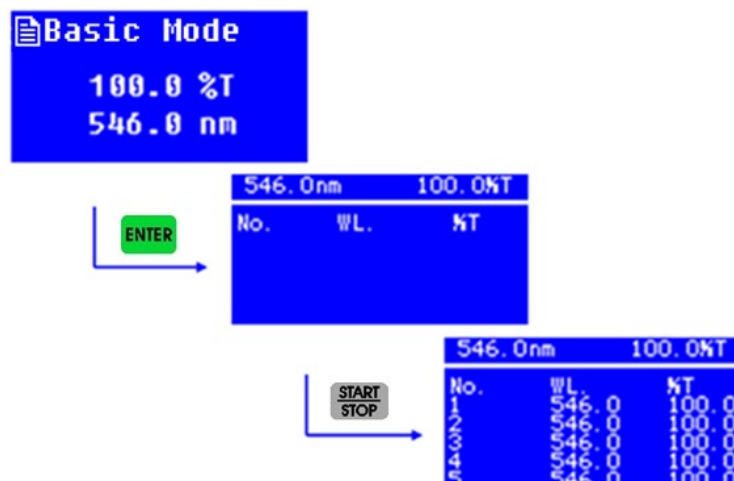

Fig. 3-10

- ☞ Before adjusting 0.000 Abs/100.0 %T, make sure that the blank solution or reference solution has been put into the light path, otherwise it may cause deviation to the measurement result.
- 🔊 There are only five rows of data records can be shown in each screen. However, user can press “▲” and “▼” to browse other data records.

3.2.2 Data processing

User can do data processing such as data saving, printing and deleting after completing the photometric measurements with multiple data records. And a brief instruction is as following.

Data saving: The system will automatically save the data record in the measurement interface. Usually, the instrument memory is enough for multiple data records.

Data printing: User can print the data if a micro-printer is connected. When it shows data records in the measurement interface, press “**PRINT**” to enter the print selection interface (Fig. 3-11), select “Yes” and press “**ENTER**”, then data records will be printed out. Otherwise, select “No” and press “**ENTER**”, or directly press “**ESC**” to return to the measurement interface.

Data deleting: If user wants to delete the data records in the measurement interface, or the storage space is full, user can press “**CLEAR**” to enter the delete selection interface (Fig. 3-12), select “Yes” and press “**ENTER**”, the data records will be cleared.



Fig. 3-11

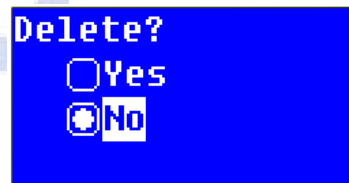

Fig. 3-12

- ☞ Please carefully do data deleting. Once performing the deleting, all the data records in this measurement interface will be cleared. If user doesn't want to delete the data records after entering the delete selection interface, can select “No” and press “**ENTER**”, or directly press “**ESC**” to return to the measurement interface.

3.3 Quantitative Analysis

User can do sample measurement based on the method of standard curve in the quantitative analysis interface.

User also can utilize coefficient method to do sample measurement.

Press “▲” or “▼” to select the function in the main interface and press “ENTER” to enter Quantitative interface (Fig. 3-13).

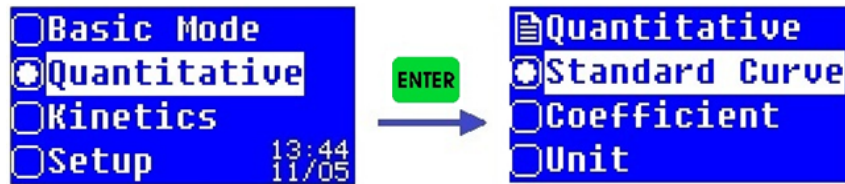

Fig. 3-13

3.3.1 Standard curve measurement



The method of standard curve means to establish a calibration curve first, then measure the sample based on the calibration curve. The standard curve is also known as the standard calibration curve.

Measure the absorbance of a group of standard solutions in ascending order of concentration, each concentration with a relevant absorbance. Utilize the absorbance as ordinate and the concentration as abscissa, draw coordinate points according to the measurement and establish a straight line that through the points as much as possible. So that obtains the standard calibration curve. The equation of the standard curve is as following formula:

$$A=K\times C+B$$

Here, A is for absorbance, K is for the slope, C is for the concentration, and B is for the intercept.

Measure the absorbance of the sample and obtain the concentration that calculated according to the standard curve.

-  Different absorbance linearity range will cause different measurement error. The best absorbance linearity range is between 0.2 and 0.8.
-  Although the standard curve is shown with the absorbance as ordinate and the concentration as abscissa, the equation of the instrument is shown as $C = K \times A + B$. However, it won't affect the sample measurement and the final result display.

1. Enter the interface of the standard curve method

In Quantitative interface, press “▲” or “▼” to select “Standard Curve” and press “ENTER” to enter Standard Curve interface (Fig. 3-14).

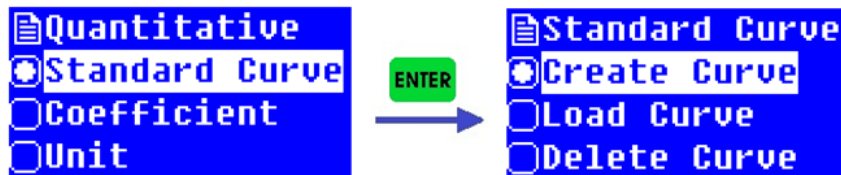

Fig. 3-14

2. Create standard curve

In Standard Curve interface, press “▲” or “▼” to select “Create Curve”, press “ENTER” to enter Fit Method interface (Fig. 3-15). Press “▲” or “▼” to select the fit method and press “ENTER” to enter the number of standard samples setting interface (Fig.3-16), then operate step by step according to the prompt and finally create the standard curve.

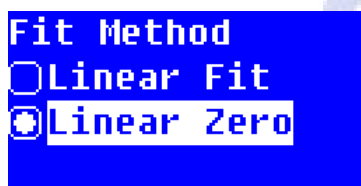

Fig. 3-15



Fig. 3-16

Following are detail operation steps for standard curve measurement:

Step 1: Fit method selecting.

User should select the fit method first after selecting “Create Curve” in Standard Curve interface, press “ENTER” to enter Fit Method interface. Then, press “▲” or “▼” to select the fit method and press “ENTER” to enter the number of standard samples setting interface.

Step 2: Measurement wavelength and standard samples number setting.

Press “GOTOλ” to enter the wavelength setting interface (Fig. 3-17) when the system gives the prompt of “Input Stds. No.”, input the value of measurement wavelength and press “ENTER” to make sure the setting. The system will return to the number of standard samples setting interface. Then, input the number value of the standard samples, and press “ENTER”, the system will enter the next operation interface.

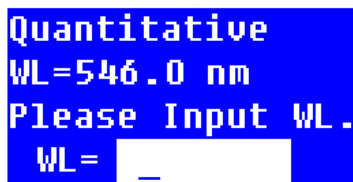

Fig. 3-17

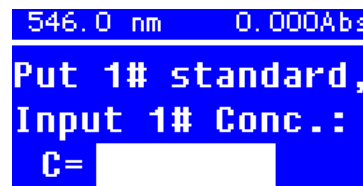



Fig. 3-18

 The valid number range of standard samples is 1-9. Otherwise, the system will automatically give buzzing alarm and return to Standard Curve interface. Usually, standard samples for a standard curve should be no less than 3.

Step 3: Standard samples measurement and standard curve establishing.

It will enter standard concentration setting interface (Fig. 3-18) after completing the standard samples number setting.

Put the reference solution of standard samples into the light path, and press “ZERO” to adjust 0.000 Abs. Then, replace the reference solution with the first standard sample solution, input the concentration value and press “ENTER” to make sure the input, press “ENTER” to make sure the data reading. Measure other standard sample solutions according to the prompt one by one. The standard curve will be obtained after completing the standard samples measurement, and the system will give the curve equation and the correlation coefficient automatically (Fig. 3-19).

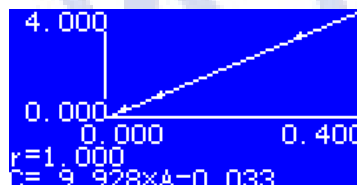



Fig. 3-19

 The valid input value of concentration is between 0.0000 and 9999. The actual absorbance value also should be regarded, for the obtained value of K should be no more than 9999.9, otherwise, the system will automatically give buzzing alarm and return to Standard Curve interface. Usually, the standard samples are measured in ascending order of concentration, and the obtained absorbance is also in ascending order. Otherwise, the system may give buzzing alarm and return to Standard Curve interface.

 Please make sure that the standard sample solution has already in the light path when inputting the concentration value during the standard samples measurement. The standard samples measurement interface doesn't show the data records. However, the data records can be printed out by micro printer.

Step 4: Sample measurement.

When the standard curve is obtained after completing the standard samples measurement, user can press “**ENTER**” or “**START STOP**” to enter the sample measurement interface (Fig. 3-20). Put the blank solution into the light path, and press “**ZERO**” to adjust 0.000 Abs. Then, replace the blank solution with the sample solution, press “**START STOP**”, the measurement result will be recorded (Fig. 3-21).



546.0 nm 0.000Abs		
No.	Abs	mε/l

Fig. 3-20

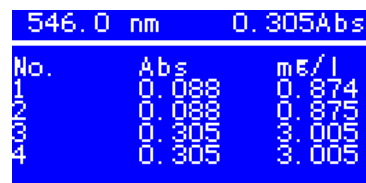

546.0 nm 0.305Abs		
No.	Abs	mε/l
1	0.088	0.874
2	0.088	0.875
3	0.305	3.005
4	0.305	3.005

Fig. 3-21

 Please remove the standard sample solution from the light path in time when completing standard samples measurement. Because the system will automatically adjust 0.000 Abs when pressing “**START STOP**” to enter the sample measurement interface, false result will be obtained if user don't do calibration with blank solution any more and directly measure the sample solution.

3. Data processing

Data saving: The system can automatically save the standard curve and sample measurement records. A number of curves and groups of data can be saved by the instrument memory.

Data printing: User can print the data if a micro-printer is connected. When it shows data records in the measurement interface, press “**PRINT**” to enter the print selection interface (Fig. 3-11), select “Yes” and press “**ENTER**”, then data records will be printed out. Otherwise, select “No” and press “**ENTER**”, or directly press “**ESC**” to return to the measurement interface.

Data deleting: If user wants to delete the data records in the measurement interface, or the storage space is full, user can press “**CLEAR**” to enter the delete selection interface (Fig. 3-12), select “Yes” and press “**ENTER**”, the data records will be cleared. If user doesn't want to delete the data records after entering the delete selection interface, can select “No” and press “**ENTER**”, or directly press “**ESC**” to return to the measurement interface.

4. Load standard curve

Saving standard curve and loading standard curve are both available with YR01846 Visible Spectrophotometer. The system will automatically save the standard curve, and user can load the standard curve. In Standard Curve interface, press “▲” or “▼” to select “Load Curve”, press “ENTER” to enter Curve Data interface (Fig. 3-22).



Fig. 3-22

 The standard curves are saved in ascending order, and the latest created standard curve is saved at the bottom. The instrument memory can store a number of standard curves.

User can press “▲” or “▼” to select the standard curve need to be loaded, press “ENTER” to make sure the selection and enter the standard curve display interface. Then, press “START STOP” to do the sample measurement (Fig. 3-23).

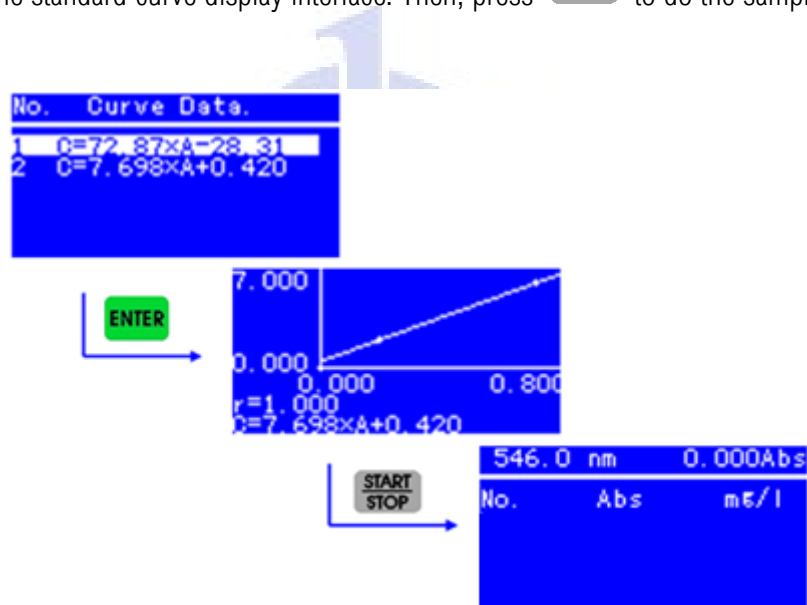

Fig. 3-23

5. Delete standard curve

User can delete the saved standard curve. In Standard Curve interface, press “▲” or “▼” to select “Delete Curve”, press “ENTER” to enter Curve Data interface. User can press “▲” or “▼” to select the standard curve need to be deleted, press “ENTER” to make sure the deletion (Fig. 3-24) and return to the previous interface.

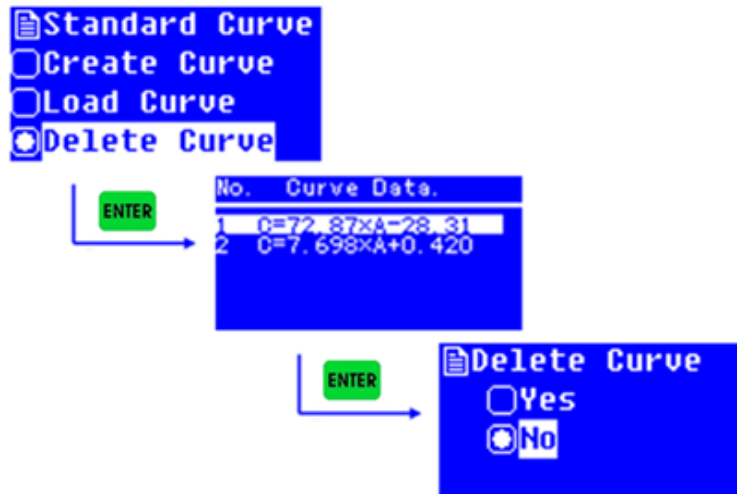



Fig. 3-24

 If user doesn't want to delete the standard curve after entering the delete selection interface, can select "No" and press "ENTER", or directly press "ESC" to return to the previous interface.

3.3.2 Coefficient method application

The coefficient method is a simple application of standard curve method. User can input the coefficients of the standard curve, and do the sample measurement further.

The calculation formula of the coefficient method is $C=K \times A+B$. Input the values of K and B, then measure the sample.

Following are detail operation steps for coefficient method:

Step 1: Enter the coefficient method interface.

In Quantitative interface, press "▲" or "▼" to select "Coefficient" and press "ENTER" to enter Coefficient interface (Fig. 3-25).

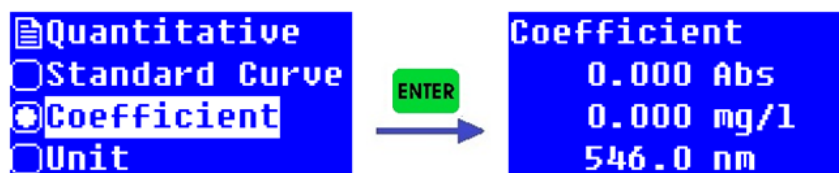

Fig. 3-25

Step 2: Coefficients setting.

User should set Coefficient K and Coefficient B before measuring with the coefficient method. In Coefficient interface, press "SET" to enter the coefficient selection interface (Fig. 3-26).

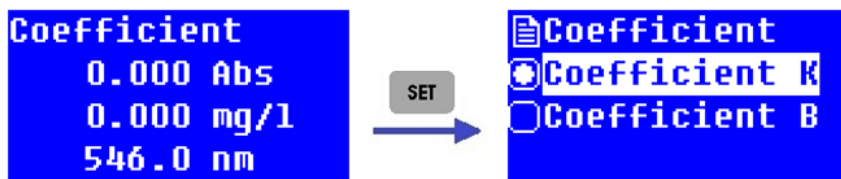

Fig. 3-26

After entering the coefficient selection interface, press “▲” or “▼” to select “Coefficient K” and press “ENTER” to enter Coefficient K interface (Fig. 3-27). Input the value of K and press “ENTER”, it will return to the coefficient selection interface. Then, user can set Coefficient B.

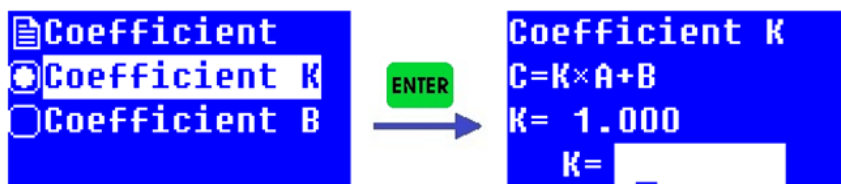



Fig. 3-27

In the coefficient selection interface, press “▲” or “▼” to select “Coefficient B” and press “ENTER” to enter Coefficient B interface (Fig. 3-28). Input the value of B and press “ENTER”, it will return to the coefficient selection interface.



Fig. 3-28

 The valid input value of Coefficient K and Coefficient B are both between -9999.9 and 9999.9. Otherwise, the system will automatically give buzzing alarm and return to the previous interface.

User can press “ESC” to return to Coefficient interface after completing both Coefficient K and Coefficient B settings, and it’s ready for the next step.

Step 3: Measurement wavelength setting.

In Coefficient interface, press the key “GOTOλ” to enter the wavelength setting interface (Fig. 3-29). Press “ENTER” after inputting the measurement wavelength, the instrument will move wavelength to the designated spot, and then return to the previous interface.

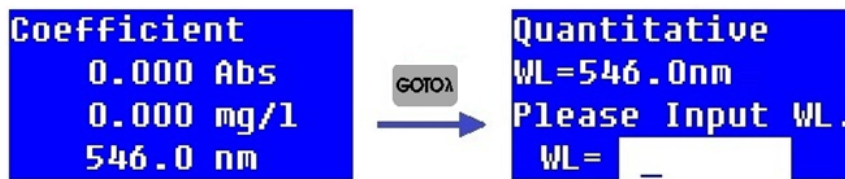

Fig. 3-29

Step 4: Sample measurement.

Press “**ENTER**” or “**START STOP**” to enter the measurement interface first after entering Coefficient interface. Put the blank solution into the light path, press “**ZERO**” to adjust 0.000 Abs. Then, replace the blank solution with the sample solution, press “**START STOP**”, the measurement result will be recorded (Fig. 3-30).



Fig. 3-30

User can do data processing such as data printing and deleting after completing sample measurement as described in the standard curve measurement.

3.3.3 Concentration unit setting

Whether utilizing standard curve method or coefficient method to do quantitative analysis, user can set the concentration unit as necessary before the measurement. Press “**▲**” or “**▼**” to select “Unit” and press “**ENTER**” to enter the concentration unit selection interface (Fig. 3-31). There are eight kinds of concentration unit for chosen, %, $\mu\text{g/L}$, mg/L , g/L , ml/L , mg/ml , $\mu\text{g/ml}$ and TCU. Press “**▲**” or “**▼**” to select the certain unit, or directly press the number key, press “**ENTER**” to make sure the setting, and the system will return to Quantitative interface.

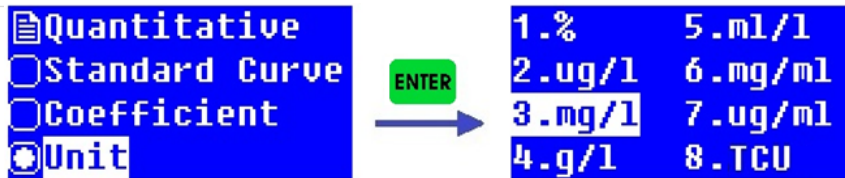

Fig. 3-31

3.4 Kinetic Analysis

A curve of absorbance or transmittance or energy at a specific wavelength in a certain time range is available with kinetic analysis, and the variation tendency of a sample can be analyzed. The data also can be printed out.

Press “▲” or “▼” to select the function in the main interface and press “ENTER” to enter Kinetics measurement interface (Fig. 3-32).

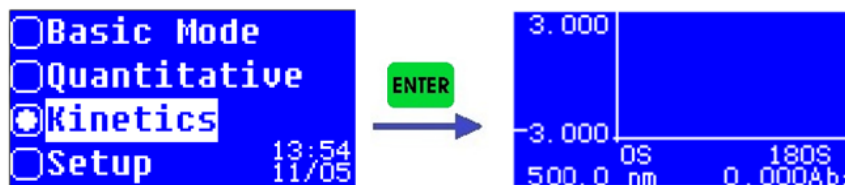

Fig. 3-32

3.4.1 Kinetic analysis

Following are the operation steps for kinetic analysis:

Step 1: Enter Kinetics measurement interface (Fig. 3-32).

Step 2: Set the kinetics parameters.

Press the key “SET” to enter Kinetics setting interface (Fig. 3-33) after entering Kinetics measurement interface.

User can set kinetics parameters such as test mode, kinetics time (Total Time), and the display range of Y-axis (Top Limit and Bottom). User also can browse the data after completing the measurement by selecting “Record List” in Kinetics setting interface.



Fig. 3-33

Test mode selection: There are three test modes for chosen, Absorbance, Transmittance and Energy. User can select “Test Mode” in Kinetics setting interface and press “ENTER” to enter the test mode selection interface (Fig. 3-34). Press “▲” or “▼” to select the wanted mode and press “ENTER” to make sure the selection. Then, press “ESC” to return to Kinetics setting interface.

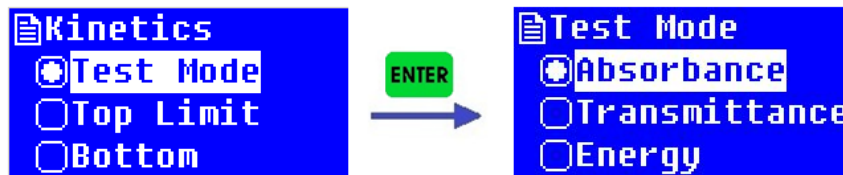

Fig. 3-34

Y-axis setting: Press “▲” or “▼” to select “Top Limit” in Kinetics setting interface and press “ENTER” to enter the setting interface (Fig. 3-35). Input the value according to certain test mode, press “ENTER” and return to the setting interface. Set “Bottom” in the same way.



Fig. 3-35

Kinetics time setting: Press “▲” or “▼” to select “Total Time” in Kinetics setting interface and press “ENTER” to enter the setting interface (Fig. 3-36). Input the time value and press “ENTER”, then, press “ESC” to return to Kinetics measurement interface.

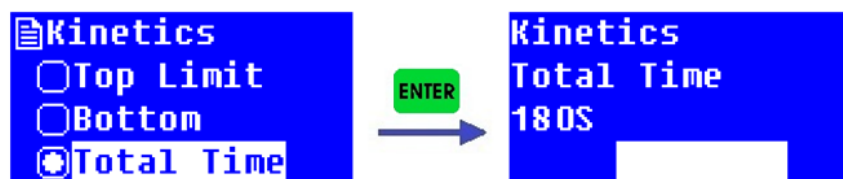



Fig. 3-36

 The valid kinetics time is between 10s and 600s.

Step 3: Set the measurement wavelength.

In Kinetics measurement interface, press the key “GOTOλ” to enter the wavelength setting interface (Fig. 3-37). Input the wavelength value and press “ENTER”, the instrument will move wavelength to the designated spot, and then return to Kinetics measurement interface.

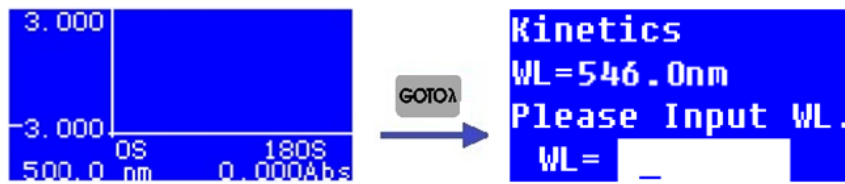

Fig. 3-37

Step 4: Kinetics measurement.

In Kinetics measurement interface, put the blank solution into the light path, press “ZERO” to adjust 0.000 Abs/100.0 %T under certain wavelength. Then, replace the blank solution with the sample solution, press “START STOP”, it will start the kinetics measurement and a dynamic curve be shown in real-time.

 If user wants to stop kinetics measurement during the measurement process, just press the key “START STOP”.

3.4.2 Data processing

User can do data processing such as data saving and printing after completing kinetics measurement.

Data saving: The system will automatically save the data records, and user can browse the data by selecting “Record List” in Kinetics setting interface.

Data printing: User can print the data if a micro-printer is connected. In Kinetics measurement interface, press “PRINT” to enter the print selection interface (Fig. 3-11), select “Yes” and press “ENTER”, then data records will be printed out. Otherwise, select “No” and press “ENTER”, or directly press “ESC” to return to Kinetics measurement interface.

For kinetics measurement, the system only saves the current measurement data, and the last measurement data will be covered automatically, user needn't to do data deleting.

3.5 System Setup

Operations such as time setting, dark current calibration, wavelength calibration, restore factory defaults and version information viewing are available in the system setup interface.

Press “▲” or “▼” to select “Setup” in the main interface and press “ENTER” to enter the system setup interface (Fig. 3-38).

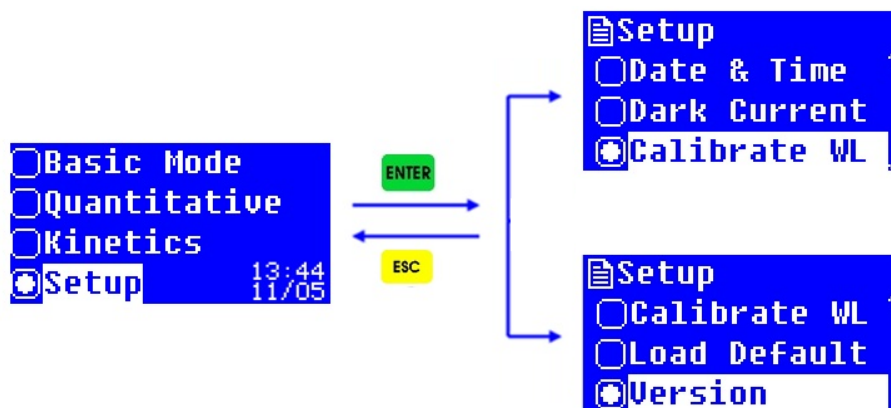

Fig. 3-38

3.5.1 Date & Time setting

Press “▲” or “▼” to select “Date & Time” in the system setup interface and press “ENTER” to enter date and time setting interface. Press “▲” or “▼” to control the cursor moving from time to date and week. Input the value when the cursor pointing to the item and set parameters of time, date and week one by one, then press “ENTER” to make sure all the settings, and it will return to the system setup interface. If user needn’t to do the setting, just press “ESC” to return to the system setup interface (Fig. 3-39).

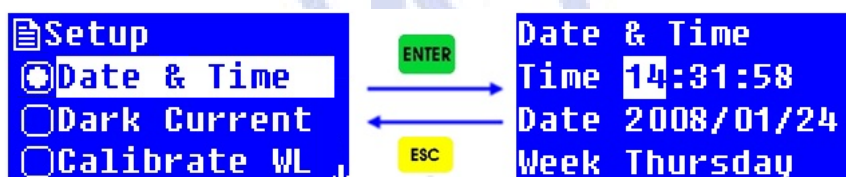



Fig. 3-39

 The valid time setting range is 0-23, 0-59 and 0-59 respectively for hour, minute and second. The valid date setting range is 0-99, 0-12 and 0-31 respectively for year, month and day. The valid week setting range is 1-7.

3.5.2 Dark current calibration

The dark current may changes when the instrument runs for a long time, or the wavelength is set again, or any other influences. For measurement accuracy, the dark current calibration is necessary before measurement.

Press “▲” or “▼” to select “Dark Current” in the system setup interface and press “ENTER” to do dark current calibration. It may cost several seconds or much more time. A prompt

“Dark current OK!” will be shown after completing the calibration, then press “**ESC**” to return to the system setup interface (Fig. 3-40).

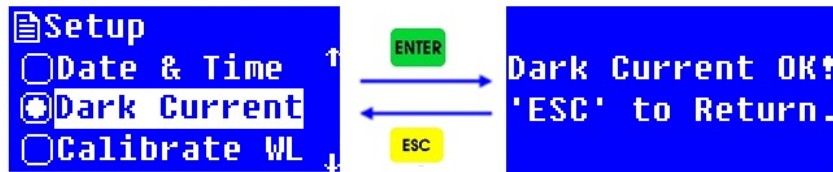

Fig. 3-40

3.5.3 Wavelength calibration

The wavelength calibration is necessary when user doubts that there is a deviation of the wavelength.

Press “**▲**” or “**▼**” to select “Calibrate WL” in the system setup interface and press “**ENTER**” to do wavelength calibration. The system will automatically calibrate the wavelength by searching the zero-order spectrum, and a prompt “Calibrating WL...” will be shown. The calibration process may cost about 1-2 minutes. A prompt “WL. OK!” will be shown after completing the wavelength calibration. Then, press “**ESC**” to return to the system setup interface (Fig. 3-41).

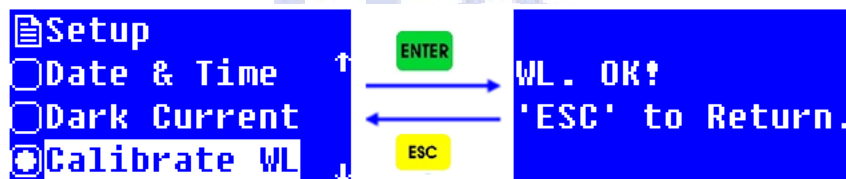

Fig. 3-41

3.5.4 Restore factory defaults

Press “**▲**” or “**▼**” to select “Load Default” in the system setup interface and press “**ENTER**” to enter the factory defaults restoring selection interface (Fig. 3-42). Press “**▲**” or “**▼**” to select “Yes” to make sure the factory defaults restoring, it will return to the welcome interface and run self-diagnosis process again. If user select “No” in the factory defaults restoring selection interface, and press “**ENTER**”, it will skip this operation, user also can directly press “**ESC**” to return to the previous interface.

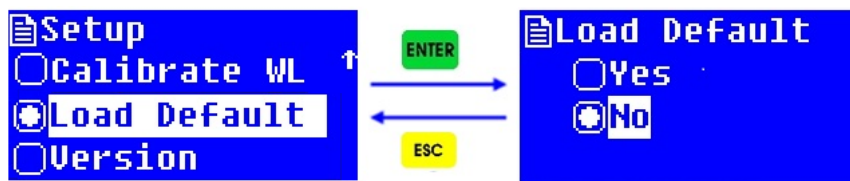



Fig. 3-42

 All the saved data including the test record, parameters setting and standard curves will be cleared by factory defaults restoring. So, please operate this item carefully.

3.5.5 Version information viewing

Press “▲” or “▼” to select “Version” in the system setup interface and press “ENTER” to enter the version information viewing interface (Fig. 3-43). User can press “ESC” to return to the previous interface.



Fig. 3-43

 The version information may change with the system updating. Please just refer to the actual information with your instrument.

Chapter 4 Maintenance

4.1 Maintenance

YR01846 Visible Spectrophotometer is a precise optical instrument. It was assembled and debugged carefully before delivery. However, appropriate maintenance will not only guarantee its reliability and stability, but also prolong its service life. Correct use is the best maintenance. In addition to previously mentioned installation requirements, following tips also should be noticed in daily use.

- (1) Before switching on the power, make sure that neither sample in the sample compartment nor any other block in the light path, and the cell holder position is all right, to avoid error during the self-diagnosis.
- (2) Please carefully load the solution into the cuvette, and the height is better no more than 2/3 of the cuvette. Try to avoid the bubble generation, for the bubble on the inner surface of the cuvette or in the solution will affect the measurement result. Please wipe off the solution that residue on the outer surface of the cuvette in time. To measure volatile samples, using with cuvette cover is suggested. Try to avoid contamination to the cell holder, otherwise, wipe off the residue solution on the cell holder promptly.
- (3) Don't touch both the two optical surfaces of the cuvette with your fingers, for the fingerprint will absorb the light and furtherly affect the measurement accuracy. Please handle the cuvette gently, for it is frangible. Clean the cuvette properly. Improper cleaning or without enough clean also will affect the measurement accuracy, even cause unstable result.
- (4) Whether placing or removing the sample, please close the lid of the sample compartment in time during the measurement. Please remove the sample from the sample compartment promptly after completing the measurement, check that there is no residue in the sample compartment and keep it dry. Any solution sample or residue left in the sample compartment may cause damage to parts of the instrument such as filter turning moldy, some components be corroded. Please open and close the lid gently.

- (5) Please switch off the instrument and disconnect the plug in time, to prevent possible damage from thunderstorms.
 - (6) Be careful in the transport. Don't place heavy object onto the instrument, to prevent the light path shift which will furtherly affect the instrument stability and measurement accuracy.
 - (7) Don't disassemble the cover and the inner parts of the instrument without authorization, especially for the optical parts. Don't loosen the tightening screws and nuts at will. All optical surfaces including the light sources can't be touched by hand or any other objects. Otherwise, it may affect the normal operation even cause damage.
 - (8) Keep the instrument surface and the working environment clean. For the surface of the cover deals with painting process, please don't clean the cover with organic solutions such as alcohol, gasoline and ether. If the instrument is not in use, user can cover the instrument with clean cloth or dust cover to avoid dust accumulation.
 - (9) A long time not in use should be avoided, and regular boot is suggested to guarantee the normal operation. In the high temperature and humidity area, user should pay more attention to keep away from moisture.
-  The instrument self-diagnosis is done for normal checking each time when switching on the power. However, the system error may accumulate after transport, moving, and using for a period of time. When the measurement data differs greatly from the experienced value, or any above situation occurs, the dark current calibration and wavelength calibration are suggested to be done.

4.2 Replacement of Tungsten Halogen Lamp

After a long time of use, the instrument needs calibrating or repairing, as its performance may have changed.

Following are the steps of replacing tungsten halogen lamp.

Step 1: Power off and unplug the power cord from the instrument.

Step 2: Remove the four screws on the sides of the spectrophotometer.

Step 3: Remove the pull rod for cell position selection by unscrewing the rod counterclockwise.

Step 4: Remove the cover of the instrument very carefully and place it backside the instrument.

Step 5: Unscrew the four screws on the bottom sides of the lamp chamber cover, and remove the lamp chamber cover.

Step 6: Unplug and remove the lamp from the lamp holder (Fig. 4-1). Insert the new lamp by pushing it in as far as it will go.

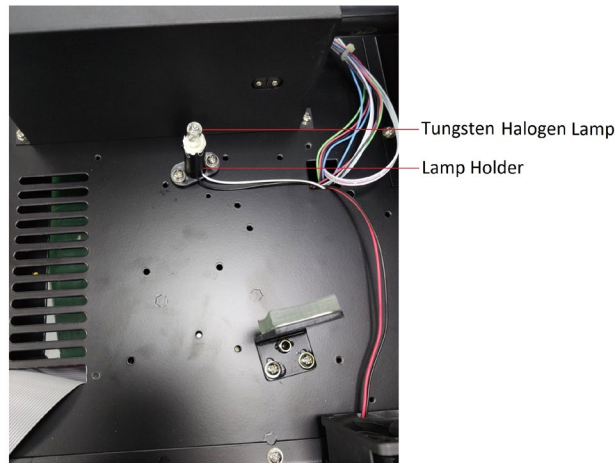



Fig. 4-1

 Do not handle the lamp with bare fingers. Use clean tissue or cloth when handling lamp. There's no difference in polarity of the two legs of tungsten lamp.

Step 7: Adjust the lamp location and focus the light spot. For detail adjustment, please refer to Service Manual.

Step 8: Reinstall the lamp chamber cover and tighten the screws. Then reinstall the instrument cover. Be sure to prevent any wires from being pinched in the process.

Step 9: Reinstall the four screws on the sides of the spectrophotometer. Reposition the pull rod for cell position selection.

4.3 Fuse Replacement



Danger! Be sure to switch off the power and unplug the socket before replacement!

Following are the steps of replacing the fuse.

Step 1: Power off and unplug the power cord from the instrument.

Step 2: Take out the fuse holder by a 3*75 flat screwdriver with blade, remove the broken fuse from the working position and replace it with the spare fuse (Fig. 4-2, Fig. 4-3).

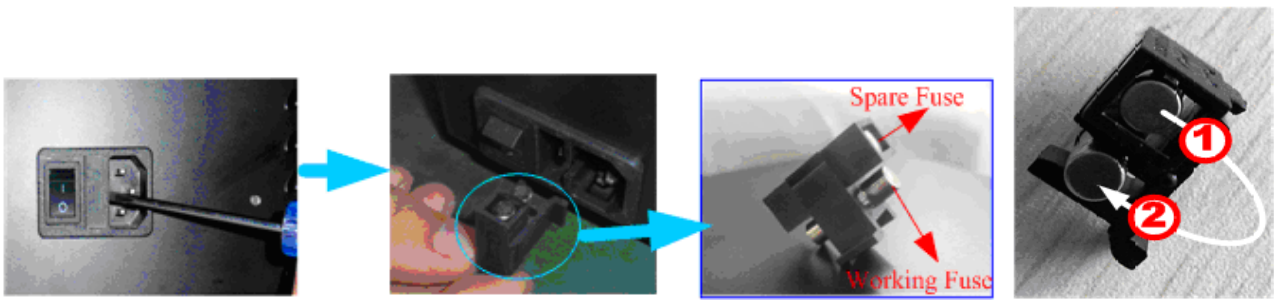

Fig. 4-2

Fig. 4-3

Step 3: Fit the fuse holder back to the position.



Chapter 5 Troubleshooting

Each YR01846 Visible Spectrophotometer is strictly debugged and inspected before delivery. Commonly, it won't appear problems in normal storage, transport and use. However, wrong operation or extreme states, and problems caused by long-term use still can't be avoided, such as the damage of electrical and optical units caused by bad storage and working environment, the damage of vulnerable units or the loosen of the fixing parts caused by improper transport, the lamp exceeds its lifetime, the wastage of electrical units, other troubles caused by wrong operation, and so on.

Please carefully refer to the related instructions before operating the instrument. Troubles and troubleshooting are introduced in following table.

No.	Trouble		Cause	Troubleshooting
1	No response when switching on the power.		1) Power disconnection.	- Check the power supply and power cord, make sure that the power supply is OK and the power cord is connected well.
			2) The fuse is burned.	- Change the fuse.
			3) The switching power supply is damaged.	- Contact the distributor or the factory technical engineer for maintenance.
2	No display or unclear display, however the fan of the power supply unit is running when switching on the power.		1) The control chip or component is damaged.	- Contact the distributor or the factory technical engineer for maintenance.
			2) Bad connection of the display, or the display is damaged.	- Contact the distributor or the factory technical engineer for maintenance or change the display.
3	Self-diagnosis Failure	Filter fault.	1) Control motor does not work.	- Contact the distributor or the factory technical engineer for maintenance.
			2) The optocoupler positioning is abnormal.	- Contact the distributor or the factory technical engineer for maintenance.

No.	Trouble		Cause	Troubleshooting
3	Self-diagnosis Failure	Detector fault.	1) Amplifier circuit fault.	- Contact the distributor or the factory technical engineer for maintenance.
			2) Filter position error.	- Contact the distributor or the factory technical engineer for maintenance.
			3) Bad connection of signal wire between the amplifier and the microcomputer board.	- Contact the distributor or the factory technical engineer for maintenance.
		Wavelength calibration fault.	1) Some sample in the sample compartment, or the lid of the sample compartment is opened.	- Check the sample compartment, make sure that no sample is in the light path. Don't open the lid of the sample compartment during self-diagnosis.
			2) Wrong position of the cell holder causes block to the light path.	- Make sure that the cell holder is in right position.
			3) The optical parts turn moldy and cause low energy.	- Contact the distributor or the factory technical engineer for maintenance.
			4) Wavelength motor fault.	- Contact the distributor or the factory technical engineer for maintenance.
			5) Filter motor fault.	- Contact the distributor or the factory technical engineer for maintenance.
		Dark current error	1) The lid of the sample compartment is opened during self-diagnosis.	- Don't open the lid of the sample compartment during self-diagnosis.
			2) Amplifier board fault.	- Contact the distributor or the factory technical engineer for maintenance.
4	The reading is not stable when adjusting 100% T or 0.000 Abs.		1) Wrong position of the cell holder causes block to the light path.	- Make sure that the cell holder is in right position.
			2) The pre-warming time is not enough.	- Pre-warming with enough time, no less than 20 min.
			3) The tungsten lamp is exhausted or with bad connection.	- Replace the tungsten lamp with a new one.

No.	Trouble	Cause	Troubleshooting
4	The reading is not stable when adjusting 100% T or 0.000 Abs.	4) Wavelength error.	- Do dark current calibration and wavelength calibration, then, try again.
		5) Light path, or the amplifier and its power supply fault.	- Contact the distributor or the factory technical engineer for maintenance.
5	The sample reading is not stable.	1) Abnormal self-diagnosis.	- Make sure that the instrument can pass through the self-diagnosis successfully.
		2) The pre-warming time is not enough.	- Pre-warming with enough time, no less than 20 min.
		3) Unstable voltage.	- Contact the distributor or the factory technical engineer for maintenance.
		4) Ambient interference, such as unstable power supply, corrosive gas interference.	- Configure with a steady power supply, keep the instrument from corrosive gas.
		5) Unstable sample.	- For the sample is unstable, measure it as soon as possible. If there is some bubble in the solution, eliminate the bubble or reload the solution. Measure with a cuvette cover for volatile sample.
		6) The cuvette is contaminated and it's too dirty.	- Make sure that the cuvette is clean before measurement.
		7) The blank value is much higher, or the sample concentration is too high and the absorbance reading is out of the stable range.	- The absorbance value of the blank solution or reference solution is better below 0.1. Dilute the sample solution properly, and the absorbance value is better between 0.2 and 0.8.
		8) The tungsten lamp is exhausted, and the energy is too weak.	- Change the light source.

No.	Trouble	Cause	Troubleshooting
6	The sample reading is not accurate.	1) Dark current drift.	- Calibrate the dark current, then measure the sample again after blank recalibrating.
		2) Cuvette matching error	- Make sure that the cuvettes matching well.
7	The printer doesn't work, or printing error.	1) Loosen connection between the instrument and the printer.	- Make sure the connection between the instrument and the printer is well.
		2) The printer model doesn't match.	- Choose the factory specified printer type.

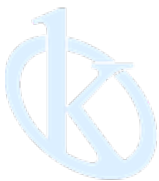

All rights reserved © KALSTEIN France S. A. S.,
 Optimum Business Center 450 Rue Baden Powell,
 • 34000 Montpellier, France.
 Tlf: +33 467158849 / +33 680760710/ +33 663810023
<https://kalstein.eu>
KALSTEIN FRANCE, S. A. S

