



Model YR05552

Moisture Analyzer

## Instruction Manual

Thank you very much for purchasing Moisture Analyzer Model YR05552. Please read the "Operating Instructions" and "Warranty" before operating this unit to assure proper operation. After reading these documents, be sure to store them securely together with the "Warranty" at a hand place for future reference.



Warning: Before operating the unit, be sure to read carefully and fully understand important warnings in the operating instructions.



## I Instruction

### 1. Security

Please reading the following before you use the Moisture Meter



a. The instrument can use for test the moisture of the sample, each improper operation may result in personal injury and equipment damage

b. Please access the AC power accordance with the manual;

c. Please make sure the power cord does not interfere with people action;



d. Do not use the instrument under the hazardous, wet or unstable environment;

e. Unplug the power before you clean the Meter;

f. Please keep enough space around the instrument, and keep the top of the space at least 1m;

g. During a special experiment, please wear protective equipment by yourself;

h. Please do not change the instrument's components and any other aspects.

Maintenance of this equipment by the factory authorized professionals.

*Moisture Meter use Halogen lamp.*



i. Do not put the flammable materials around the instrument;

j. Do not touch the halogen lamp when it on working.

*Special attention to the dangers of some sample;*

k. Before you test the moisture of dangerous good, please take Full investigation



*Inflammable and explosive materials: Heating the inflammable and explosive*

*materials will produce flammable gases or vapors, so need to lower the temperature in a dry environment. In case of fire or explosion.*

*Toxic and corrosive substance: Keep the samples of toxic or corrosive ingredients in well-ventilated environment.*

*Above the sample test will be particularly careful, for any damage caused by your own risk*

1

### Tips:

1. Warm-up the Meter 30 minutes and take the first-time calibration;

2. After the end of a water calibration experiments (see 3.6);

3. Each time the switch machine, please interval of 5 seconds;

4. Cover the heater, do not leave the weight on the pan, or halogen lamps will be crushed;



### Schedule: assembly drawing

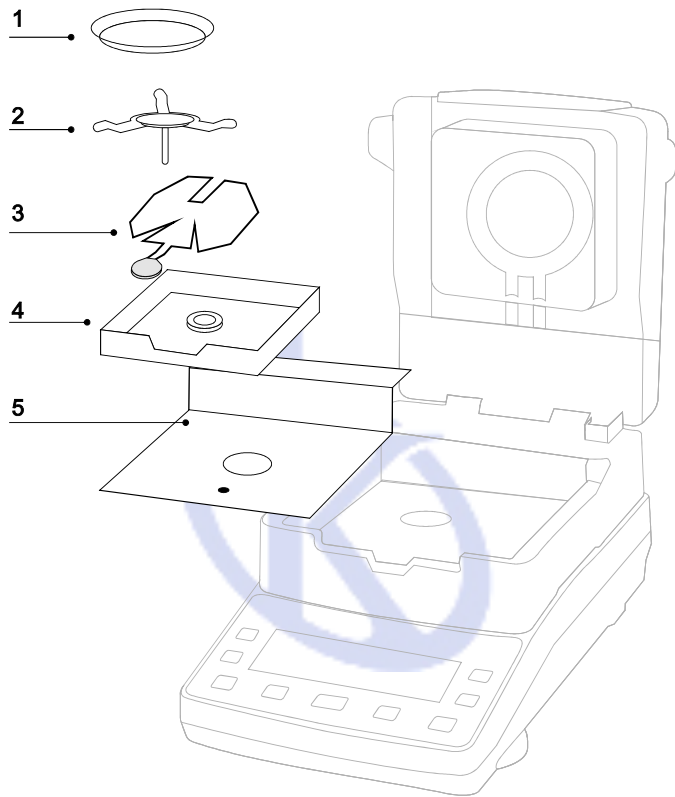

Please installation the instrument according the picture

Installation order from top to bottom :1 --2--3--4--5

1. Aluminum scale pan
2. The triangle scale frame
3. Scale pan brackets
4. Wind cover
5. Stainless steel plate

### 2.1 Standard Packing List

Please check whether the packaging and accessories is complete when you open it

Standard	Quantity	Note
Moisture Meter Mainframe	1 set	
Wind Cover	1 piece	
The sample pan holder	1 piece	
Tray handle	1 piece	
Power cord	1 piece	
Aluminum sample pan	1 set	50pcs
100g standard weight	1 piece	
Product Manual	1 piece	
Product certification	1 piece	
Warranty card	1 piece	

### 2.2 Operating Requirement



Operating table

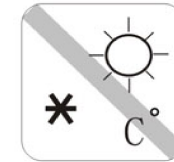

Temperature stable, good ventilation should be stable dry, without strong vibration, of the environment without strong magnetic field.



### 2.3 Installation of accessories

Place the wind cover, aligned holes.	Place the sample pan holder, rotate until positioning.	Put the aluminum sample pan on the bracket.



### 2.4 Adjust the level and connect the power



There are two feet in front of the instrument, adjust it and keep the instrument level.



Connect the instrument with power, put one side of power cord



Please warm up more than 30minutes for keep it stable and accurate.

## III Operation

### 3.1.Display



### 3.2.Icon Introduction

**%** ----The percentage of dry weight      **m %** ----The percentage of moisture

**g** ----Gram      **188°C** ----Temperature

**88:88T** ---- Time set and heat time

----Heated mode

----Standard mode      ----Rapid heating mode

---- Gentle heating mode

---- Stop heated mode

### 3.5 Calibration

When the instrument error or improper operate. Calibration weights can be adjusted with accuracy.

Press "Reset" key and does not release until it display“-cal-”,

Then flashing “100.000”, put on the calibration weight, then it will display “= = = = =”, until it display “100.000” remove the weight, it will display “= = = = =” again, Waiting it show “0.000 ”, the calibration is completed.

## IV Technical parameters

Mode	YR05552
Specification	110g/10mg
Readability	10mg
Pan size	Φ 90
Heating mode	Halogen lamp
Display	LCD
Temperature Setting	40°C~199°C
Time Setting	1~99 minutes
ATRO	100%~999%
ATRO	0%~999%
History store	15 set
Power supply	220V 50Hz



when flashing  Press "UP" or "Down" to choose the stop mode. And press "ENTER" confirm, Parameters are defined, and go to the next parameter (temperature) setting.

### 3.5.4 Heating Temperature Setting

The instrument temperature setting range is from 0-199 degrees. Press the "MENU" to enter the parameter setting mode, press the "ENTER" key until the

**188°C** flashing, Press "UP" or "Down" to choose the temperature. And press "ENTER" to go to next setting (time setting)

Icon **188°C** will transform other temperature when its heating.

### 3.5.5 Heating time setting

1. Just choose timing stop mode need set the stop time.



Press the "MENU" to enter the parameter setting mode, press the "ENTER" key until the **88:88T** flashing, Press "UP" or "Down" to choose the temperature. And press "ENTER"

2, Heating cycle: Just gentle heating mode need choose heating cycle

### 3.6 For example:

- a. sample: water,
- b. Press the "MENU" to enter the parameter setting mode, choose the , temperature: 120°C, Press "ENTER" go to weighing state
- c. Put a dry paper on the pan, and press "Tare" clean the weight. Put on the 3g water on the paper, until the readability stable. Press "START / STOP" begin test. Waiting for it sop. Look the result. The m% will be 100%.

Weighing error or sample weight deficiency can lead to the result of the test a deviation

 Automatic  
 Timing stop mode

 Manual stop mode

 Heated state

### 3.3. Keypad

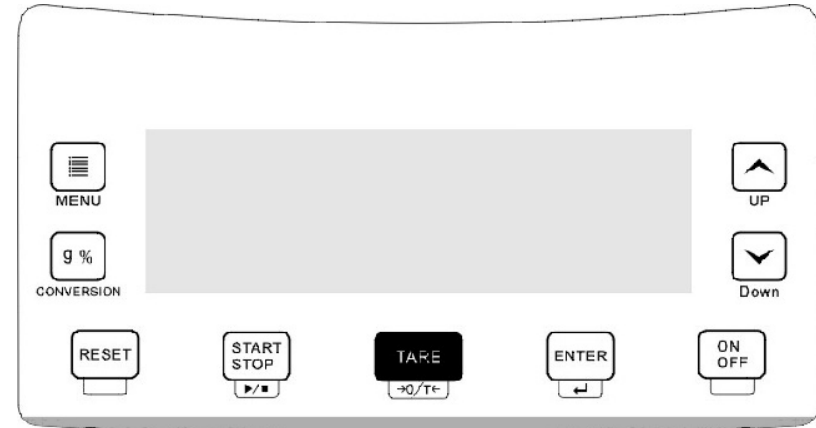

NAME	Key features
ON/OFF	Power on / off, Just off the internal DC power supply
START / STOP	Start heated/ stop heated
TARE	Weighing peeled, Settings exit
MENU	Enter the setting menu
CONVERSION	Switching measurement results
ENTER	Confirm the current setting, go to next
RESET	Return to the weighing mode (short press), calibration balance (long press)
DOWN	Reduce
UP	Add



### 3.4 First testing

1. First test, if not change the temperature and time settings, the moisture meter defaults to factory defaults.
2. Put empty sample pan on the holder (see section 2.3).
3. Press the "TARE" to clean weight.
4. Put the sample on the pan (Sample weight should be heavy than 1g, the general 3-5g).
5. Close the heating cover, press the "Start / Stop" button to start the test. At this point, heated tube lights, fans turn on, heated symbol in the upper left flashing. While rolling on the screen displays the current temperature, has been heating time, moisture content of the current sample.
6. End of the test, heated lamp automatic shut off, the buzzer alarm. Then the sample is displayed on the moisture content, heating time, current temperature and the parameter setting mode.

*Note: Don't touch the sample plate, the temperature is too high now.*

7 Press the "Reset" button, the instrument returns to weighing mode.

### 3.5 Parameters Setting

#### 3.5.1 Heated parameter storage and recall

- a. The instrument can store a total of 16 0-F group of heated parameters. Each group can set the heating method, stop mode, time and time test parameters.
- b. In weighing mode, press the "Settings" button to enter the parameter setting mode, then store the address number (the number show the highest bit) is flashing. Press "down" or "up" key to select the desired address number, the 0 is the factory setting, 1-F for the user store.
- c. The memory address number 0 means factory settings, then click "ENTER" button to exit the settings back to weighing mode. At this point heated mode is the factory defaults.
- d. When the memory address range for the 1-F any one number, press "ENTER" key, and enter the parameter setting after the completion of a parameter (heated mode, stop mode, time mode) setting. Press the "TARE" key, the address number of the test parameters have been stored.

#### 3.5.2 Heated mode and setting ( )

#### a. Standard heated mode: ( )



This mode is the factory setting, suitable for most samples. Heating temperature can be set, the sample is heated to a temperature, and keep to the test ends automatically.

#### b. Rapid heating mode: ( )

This mode is suitable for samples with higher moisture content. You can set the heating temperature, heating the temperature will exceeds the set value, the future will be reduced to the set temperature and hold until the test ends automatically.

#### c. Gentle heating mode: ( )

This mode is suitable for low moisture content, surface casing is easy to form, easy to burn the sample. From the heat began to rise to the long time required to set temperature, heating up even slowly. Heating time user selectable.

d. Press the "MENU" to enter the parameter setting mode, 0 to 1, press the "ENTER" until the heating mode, the icon flashes . Press "UP" or "L"  choose the mode you need. And press "ENTER" confirm.

#### 3.5.3 Stop mode setting: ( )

##### a. Automatic stop mode: ( )

Heating the sample within the specified time during the weight loss of less than 2mg will automatically stop when the test. This mode after 15 seconds in the heating effect.

##### b. Manual stop mode: ( )

Sample heating process is the continuing until the press the "start/stop" button to end testing.

##### c. Timing Stop Mode: ( )

Stop time set by the user, the sample heating process is continued until the end of the heating time to set the value of the test.

Press the "MENU" button to enter the parameter setting mode, press the "ENTER" key until the shutdown mode



<https://kalstein.net/>

---

