

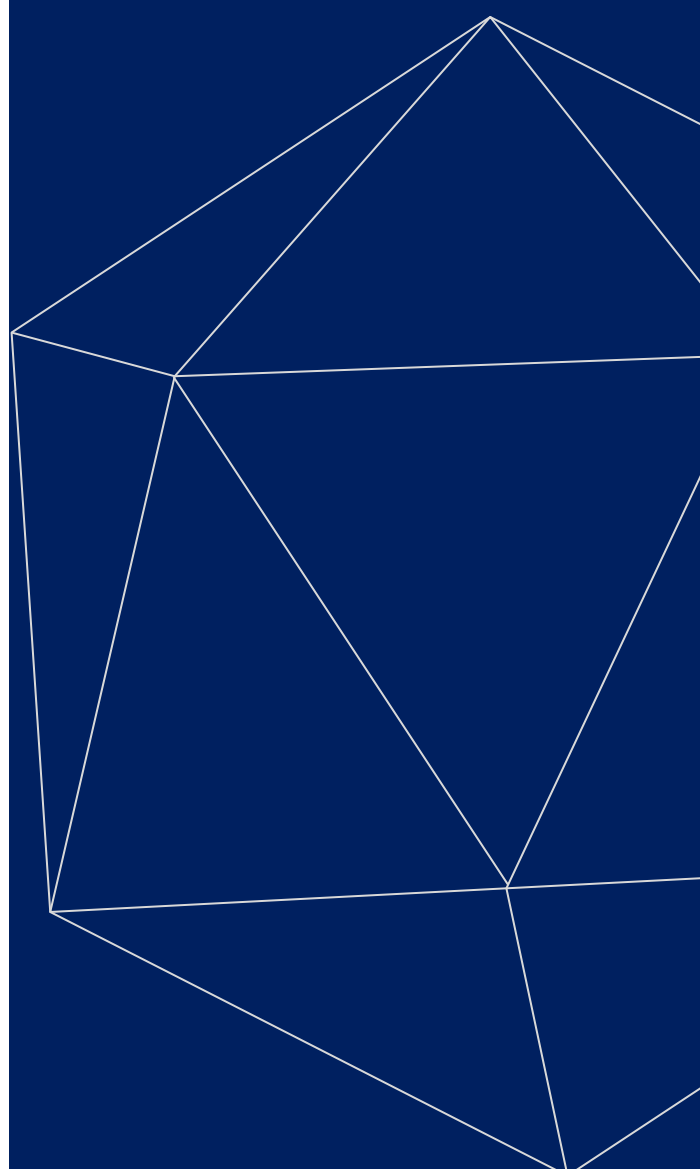

LABORATORY LINES

MICROSCOPE



Kalstein®

A different accompaniment, at your service

All rights reserved © KALSTEIN France S. A. S.,



All rights reserved © KALSTEIN France S. A. S.,
2 Rue Jean Lantier • 75001 Paris •
+33 1 78 95 87 89 / +33 6 80 76 07 10 •
<https://kalstein.eu>
KALSTEIN FRANCE, S. A. S



OUR SERVICES

Benefits and Support

In Kalstein France, we take care of the full satisfaction of our customers, that is why we provide value-added services of the highest level based on our experience.



Online Inductions and Trainings

In any part of the world, receive your induction or training from our specialized team of engineers



Quick Response

Our work team is always available to response all your consults or questions, in order to support you in any situation.



#Letsgivemore

Thanks to your purchase, a donation will be made to a non-profit foundation that fights against breast cancer and helps most vulnerable communities.



Technical Support

Enjoy of personalized advice for the correct preventive and corrective maintenance of your equipment, thanks to Kalstein's manuals and articles, special catalogues and video tutorials.



Delivery Logistics

We take care of all the necessary logistics for the dispatch of your goods, whether is by sea, land or air.



Kalstein Worldwide

With more than 25 years growing with our customers, Kalstein's multiformat and modern content, is now present in more than 10 countries and increasing.



KALSTEIN® Microscope Laboratory Microscope Model YR01038



#Letsgivemore ♥

Thanks to your purchase, a donation will be made to a non-profit foundation that fights against breast cancer and helps most vulnerable communities.



All rights reserved © KALSTEIN France S. A. S.,
2 Rue Jean Lantier • 75001 Paris •
+33 1 78 95 87 89 / +33 6 80 76 07 10 •
<https://kalstein.eu>
KALSTEIN FRANCE, S. A. S



KALSTEIN® Microscope Laboratory Microscope

Model YR01038

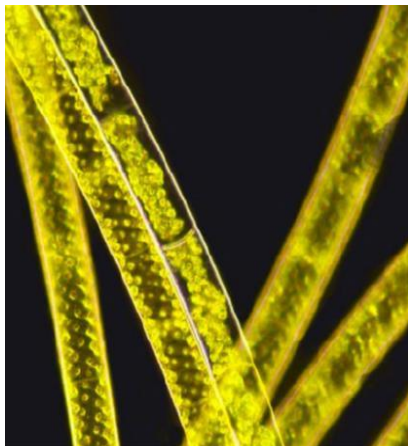

Bright Field Dark
Field Phase
Contrast
Simple Polarizing
Observation
Combined



Upgradeable To
Fluorescence
Microscope

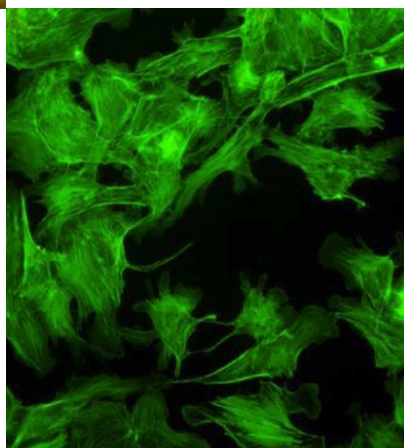

#Letsgivemore 

Thanks to your purchase, a donation will be made to a non-profit foundation that fights against breast cancer and helps most vulnerable communities.



All rights reserved © KALSTEIN France S. A. S.,
2 Rue Jean Lantier • 75001 Paris •
+33 1 78 95 87 89 / +33 6 80 76 07 10 •
<https://kalstein.eu>
KALSTEIN FRANCE, S. A. S



YR01037 & YR01038



High-quality Microscope with Practicality and Durability

The YR01037 & YR01038 microscopes are specially designed for various microscopy needs such as teaching and clinical diagnosis. It has good optical quality, wide field of view, excellent objective performance, clear and reliable imaging. Ergonomic design provides better comfort and use experience, pays attention to the user's operating habits, starts from the details, and constantly optimizes. Modular design can realize various observation methods such as bright field, dark field, phase contrast, fluorescence, etc., providing more possibilities for your scientific research and exploration. It takes up little space and is very convenient for handling, storage and maintenance, and is the first choice for microscope beginners.

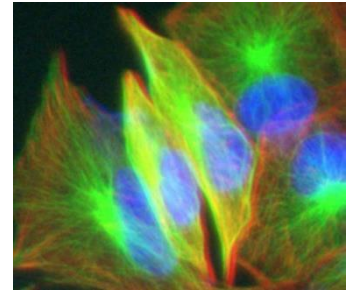
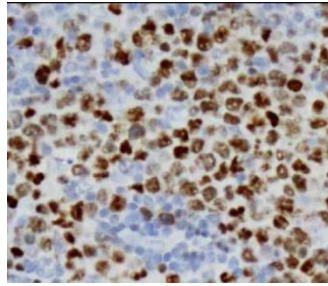
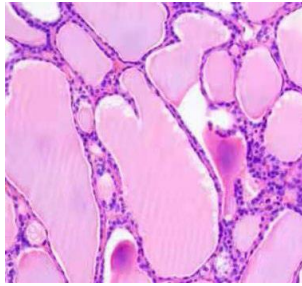

YR01037 Upgrade To YR01038

- Condenser Upgrade To Coded Nosepiece
- Stand Upgrade To With LCD Screen



Realize Various Observation Methods

YR01037

YR01038

Observation Methods	Bright Field	Dark Field	Phase Contrast	Fluorescent	Simple Polarizing
	•	•	•	•	•

YR01037 & YR01038 Dimension

Unit: mm

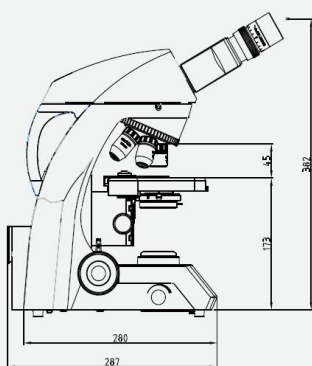

YR01037

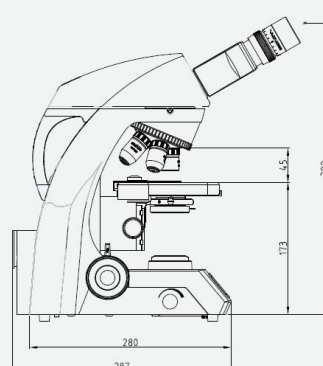
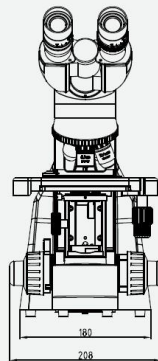

YR01038

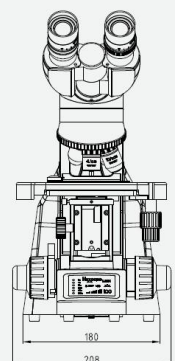

#Letsgivemore

Thanks to your purchase, a donation will be made to a non-profit foundation that fights against breast cancer and helps most vulnerable communities.



All rights reserved © KALSTEIN France S. A. S.,
 2 Rue Jean Lantier • 75001 Paris •
 +33 1 78 95 87 89 / +33 6 80 76 07 10 •
<https://kalstein.eu>
 KALSTEIN FRANCE, S. A. S



Excellent Optical Imaging



Excellent Image Quality

The NIS optical system of scientific research microscope is applied to student microscope for the first time. Excellent optical system is the guarantee of obtaining smooth and clear images. Achromatic objective and even plan objective can be used in this microscope. It can provide clear images with high contrast, and the clear range can reach to the edge of the field of view. It has bright and uniform illumination. NIS optical system and optical elements using advanced coating technology make it easy to obtain good quality imaging.

Wide Field Of View

The N-127 / N-128 microscope can achieve the 20mm wide field of view under the 10X eyepiece, with more comprehensive observation content and faster sample observation. The eyepiece adopts the plan and distortion-free design to prevent the appearance of the edge of the field of view from becoming false, and the phenomenon of variegated apertures.

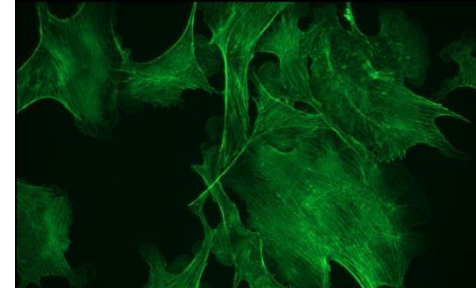
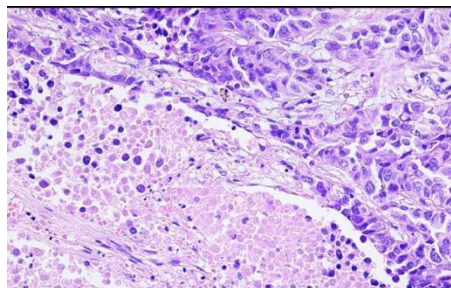
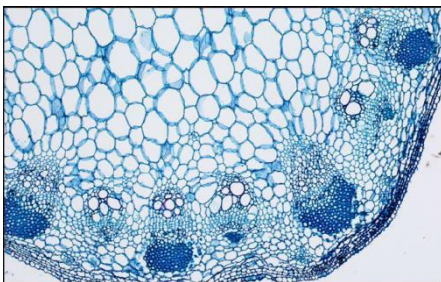
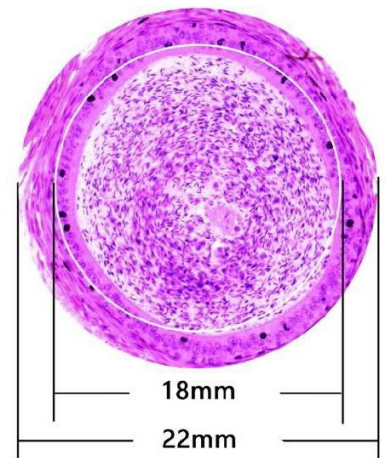

Uniform Illumination And Adjustable Color Temperature

LED light source produces sunlight illumination conditions, which makes the sample present natural color. Its color temperature changes according to observation needs, even if the user changes the brightness, it can maintain the brightness and color temperature comfortably. The LED design life is 60,000 hours, which not only reduces maintenance costs, but also stabilizes the brightness during use.

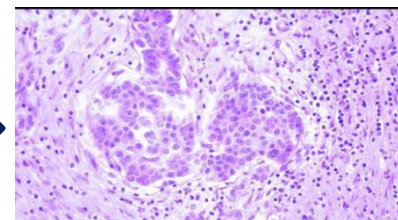
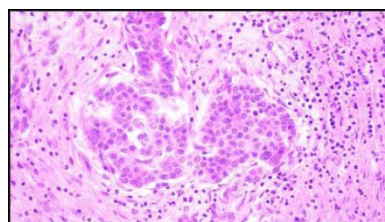
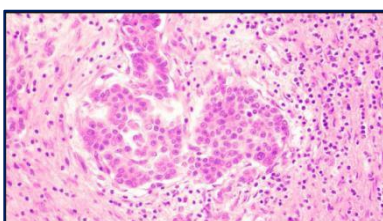

#Letsgivemore

Thanks to your purchase, a donation will be made to a non-profit foundation that fights against breast cancer and helps most vulnerable communities.



All rights reserved © KALSTEIN France S. A. S.,
2 Rue Jean Lantier • 75001 Paris •
+33 1 78 95 87 89 / +33 6 80 76 07 10 •
<https://kalstein.eu>
KALSTEIN FRANCE, S. A. S



This is a Microscope with Convenient Maintenance



Applicable to Any Environment

Anti-mildew treatment to improve accessories durability. Since the objective, eyepiece and observation tube are all effectively anti-mildew, they can ensure a continuous and clear image and prolong the service life of the microscope. Working in hot and humid environment is not affected.

Easy to Store and Transport

The microscope is small enough to fit into a common classroom wall cabinet. There is a special carrying handle, and it has light weight, good stability and stable structure. The back panel of the microscope is designed with a hub device, which can effectively store the long power cord, improve the cleanliness of the laboratory, and also reduce the trip accidents caused by the long power cord during transportation. Wooden storage box as an optional accessory can bring great convenience for storage and handling.



Use Friendly Microscope

Ergonomic Design

This microscope adopts ergonomic design, high eye point, low-hand focusing mechanism, low-hand stage and other series of ergonomic designs to ensure that users can operate the microscope under the most comfortable conditions and minimize the use of fatigue.

Extremely Smooth Nosepiece

High-precision machining ensures smoothness and durability in use. The nosepiece has a rubber ring, which is ergonomic and easy to convert.

Stage Designed for Beginners

The reckless stage prevents users from being scratched by exposed parts during use.

The slice clip can be easily operated with one hand.

When the upper limit of the stage is locked, accidental contact between the objectives and the slide can be avoided.

In order to prevent damage to samples and objectives, the coarse quasi-focus torque adjustment device can adjust the comfort of use according to personal operating habits.



#Letsgivemore 

Thanks to your purchase, a donation will be made to a non-profit foundation that fights against breast cancer and helps most vulnerable communities.



All rights reserved © KALSTEIN France S. A. S.,
2 Rue Jean Lantier • 75001 Paris •
+33 1 78 95 87 89 / +33 6 80 76 07 10 •
<https://kalstein.eu>
KALSTEIN FRANCE, S. A. S



Upgrade to Intelligent Microscope

MICROSCOPE



WiFi Digital Head

Built-in high-definition digital camera, support 500W, 1080P, 720P resolution video stream real-time WI-FI preview. Supporting Android, IOS, windows operating system, stand- alone use, online interactive access. The high-definition images under the microscope can be output to external devices in real time, and there is no data cable connection, the operator is more free to move. Observation, analysis and processing of microscopic imaging can be realized in external equipment, including photographing, measurement, image adjustment, storage, synthesis, etc.

Coding Nosepiece

It can remember the illumination brightness when using each objectives. When different objectives are switched between each other, the light intensity is automatically adjusted to reduce visual fatigue and improve work efficiency.

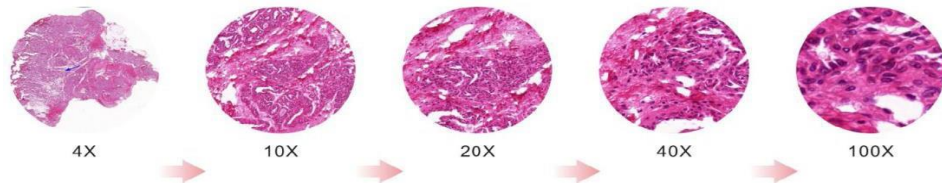

Microscope Use Status Display

The LCD screen on the front of the microscope can display the use status of the microscope, including magnification, light intensity, standby status, etc.

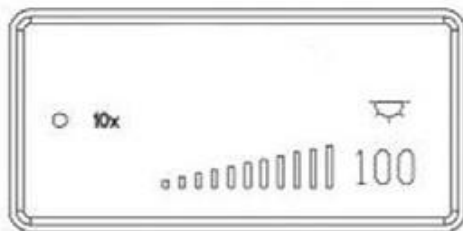

Start & Working Mode

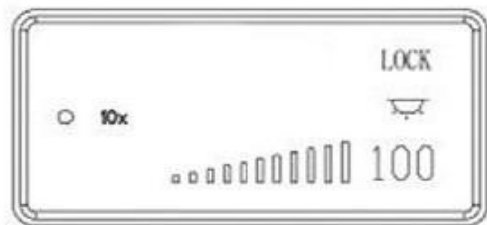

Lock Mode

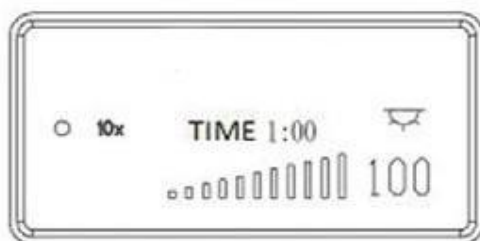

ECO Mode



Sleep Mode



#Let'sgive more

Thanks to your purchase, a donation will be made to a non-profit foundation that fights against breast cancer and helps most vulnerable communities.



All rights reserved © KALSTEIN France S. A. S.,
2 Rue Jean Lantier • 75001 Paris •
+33 1 78 95 87 89 / +33 6 80 76 07 10 •
<https://kalstein.eu>
KALSTEIN FRANCE, S. A. S



Product Specification

YR01037, YR01038 Laboratory Microscope		YR01037		YR01038	
		-B	-T	-B	-T
Optical System	Infinity Optical System	●	●	●	●
Observation Method	Bright Field	●	●	●	●
	Dark Field	○	○	○	○
	Phase Contrast	○	○	○	○
	Epi-Fluorescence	○	○	○	○
	Polarizing	○	○	○	○
Head	Seidentopf Binocular Head, Inclined 30°, Interpupillary Distance 47- 78mm, Eyepiece Tube Dia.23.2mm	●		●	
	Seidentopf Trinocular Head, Inclined 30°, Interpupillary Distance 47- 78mm, Eyepiece Tube Dia.23.2mm, Light Split Switchable E0:P100/E100:P0		●		●
	WiFi Digital Binocular Head, Inclined 30°, Interpupillary Distance 47- 78mm, Eyepiece Tube Dia.23.2mm 5.0M Digital Camera Built-in, WiFi Transmission Rate 1680p, Support Android, IOS, Windows, Stand-Alone Use, Online Interactives Access.	○	○	○	○
Eyepiece	EW10x/20mm, Diopter Adjustable, Dia.23.2mm	●	●	●	●
Nosepiece	Quintuple Nosepiece, Dovetail Interface	●	●	-	-
	Coded Quintuple Nosepiece, Dovetail Interface	-	-	●	●
Infinity S-Plan Achromatic Objective	4x/0.10, W.D.28mm	●	●	●	●
	10x/0.25, W.D.5.8mm	●	●	●	●
	40x/0.65(S), W.D.0.43mm	●	●	●	●
	100x/1.25(S.Oil), W.D.0.13mm	●	●	●	●
Infinity Plan Achromatic Objective	4x/0.10, W.D.28.0mm	○	○	○	○
	10x/0.25, W.D.10mm	○	○	○	○
	40x/0.65(S), W.D.0.7mm	○	○	○	○
	100x/1.25(S.Oil), W.D.0.18mm	○	○	○	○
Focusing	Coaxial Coarse and Fine Focusing Knob, Left Hand Has Height Limit Function, Right Hand Has Coarse Motion Adjustment Function .Coarse Stroke 37.7mm per Rotation, Fine Division 0.002mm, Fine Stroke 0.2mm per Rotation, Moving Range 20mm	●	●	●	●
Working Stage	Double Layers Mechanical Stage 150x140mm, Moving Range 75x52mm	●	●	●	●
Condenser	Abbe Condenser N.A.1.25	●	●	●	●
Illumination	3W LED Illumination, Brightness Adjustable, Green Filter	●	●	●	●
	Kohler Illumination	○	○	○	○
	LCD Screen Magnification, Brightness, Color Temperature	-	-	●	●
Dark Field	Dark Field Condenser, Dry	○	○	○	○
	Dark Field Condenser, Oil	○	○	○	○
Phase Contrast	Phase Slider For 10x-40x	○	○	○	○
	Phase Slider For 100x	○	○	○	○
Fluorescence	LED Fluorescent Illumination	○	○	○	○
	Mercury Fluorescent Illumination	○	○	○	○
Photo Adapter	1.0x C-Mount	○	○	○	○
	0.5x C-Mount	○	○	○	○
Power Supply	AC 100-240V,50/60Hz	●	●	●	●
	USB Charging Port, Support To Use Exeternal Rechargeable Battery Power Bank, Out Door Freely	○	○	○	○
LCD Screen	LCD Screen On Front Of Body, Display Using State Of Microscope, Including Magnification, Light Intensity, Standby Status, Set Power Off Timer 5 Mins to 8 Hours, And So On.	-	-	●	●
Dimensions	220(W)x290(D)x472(H) mm	●	●	●	●

Note: "●" In Table Is Standard Outfits, "○" Is Optional Accessories "-" Is Unavailable



Kalstein®

A different accompaniment, at your service

#LETSGIVEMORE

**WITH THE
ACQUISITION
OF A
KALSTEIN
EQUIPMENT**

YOU MAKE A CONTRIBUTION
TO:



Fundación
Jacinto Convit

<https://www.jacintoconvit.org/>



<https://onetreepanted.org>



Humatem

Solidarité et coopération
biomédicale

<https://www.humatem.org/>



**MANIAPURE
FOUNDATION USA**

<https://www.maniapurefoundation.org/>



Kalstein®

A different accompaniment, at your service

ANY DOUBT?

Contact us!

Articles Kalstein

(Social Networks and Official Websites)



Kalstein Blog

Not just be informed, be fully informed

The 3 articles of the week!



Read more on Kalstein's social medias or official websites
<https://kalstein.eu/articles>

1

Read this ARTICLE NOW



Kalstein Blog

Article of the week:
How does the climate affect your microscope?

Read more on Kalstein's social medias or official websites
<https://kalstein.eu/articles>

2

Read this ARTICLE NOW



Kalstein Blog

Article of the week:
What is the importance of the laboratory refrigerator?

Read more on Kalstein's social medias or official websites
<https://kalstein.eu/articles>

PARIS - FRANCE

HEADQUARTER

2 Rue Jean Lantier

75001 Paris - France

Tif: +33 (0) 01 78 95 87 89

Cel: +33 (0) 6 80 76 07 10

sales@kalstein.eu

<https://kalstein.eu/>

<https://www.kalstein.fr/>

Kalstein Training Videos

(Youtube Channel and Official Websites)



2:34

Kalstein France - Jacinto Convit Foundation / Allianc...

23 views • 3 years ago



0:42

Kalstein's Microscopes

445 views • 1 week ago



All rights reserved © KALSTEIN France S. A. S.,